

*Mark Petersen, Steven Brus, Darren Engwirda,  
Andrew Roberts, Kevin Rosa, Phillip Wolfram*

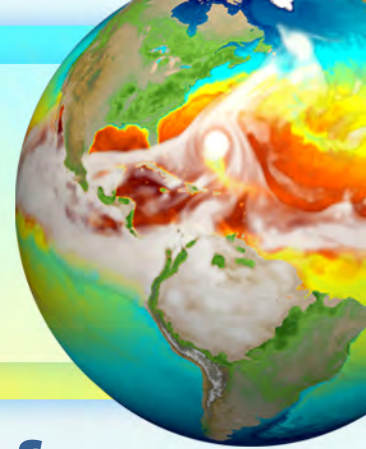

# **MPAS-Ocean Simulation Quality for Variable-Resolution North American Coastal Meshes**

*How does mesh design impact simulation  
quality?*

Kristin Hoch

# CUSP Mesh

- Coastal United States 'Plus'
- Build on EC60to30 background mesh
- 8 km coastal resolution
- 400 km wide resolution region
- 600 km transition region

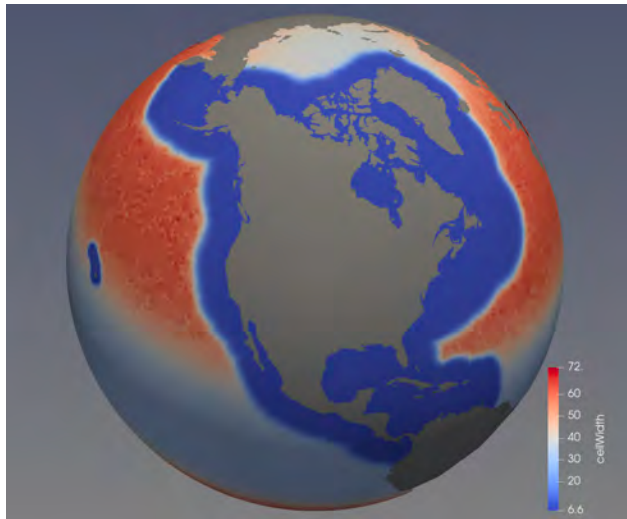

Final CUSP8 Design

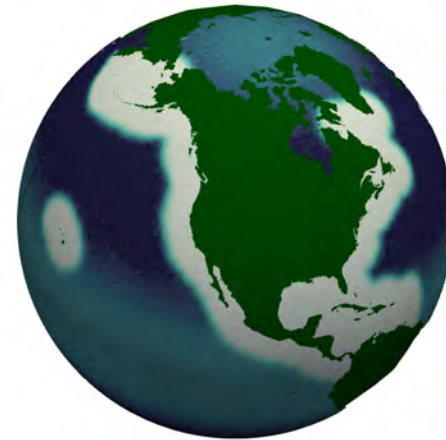

CUSP8



North Atlantic (NA8)

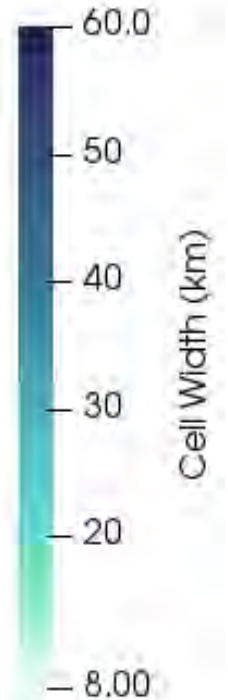

# Study Overview

- Study 1: Degraded Mesh
  - *What is the effect of mesh quality on simulations?*
  - Intentionally degraded cells on an EC60to30 mesh
- Study 2: Transition Width
  - *How wide does the transition region between the high resolution region and the low resolution background mesh need to be?*
  - Changed the transition width of the CUSP8 mesh from 10 km to 900 km
- Study 3: Coastal Resolution
  - *Does improving the coastal resolution improve the dynamics of the Gulf Stream?*
  - Changed the coastal resolution of the CUSP mesh from 8 km to 30 km



# Study 1: Degraded Mesh

## Two measures of mesh quality

### 1) Ratio of smallest to largest side of cell

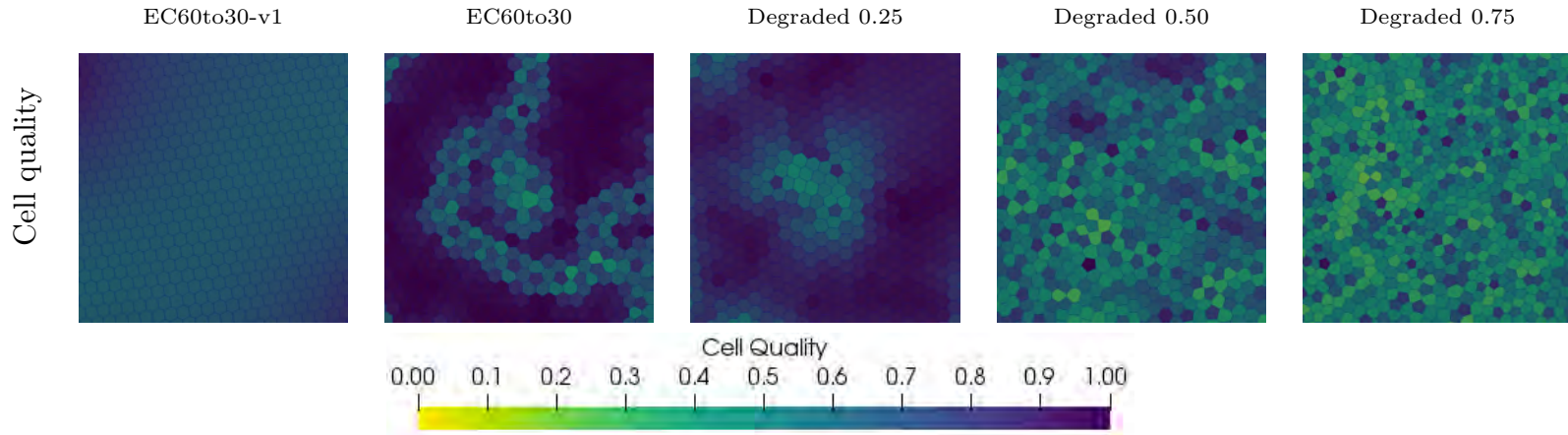

### 2) Maximum percent change in cell area between adjacent cells

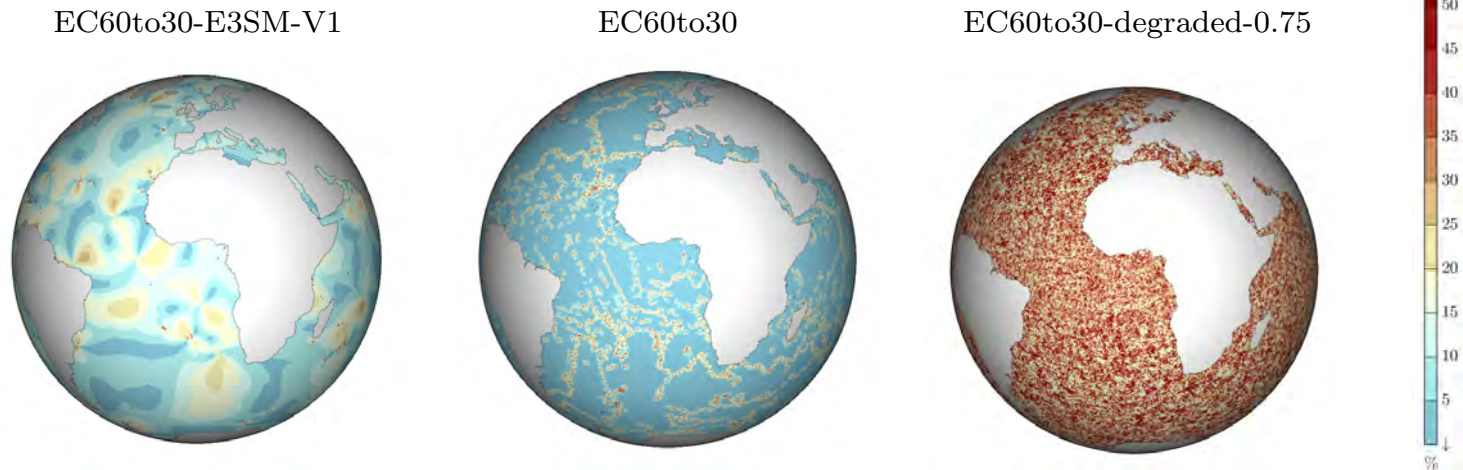



# Study 1: Degraded Mesh

- Degraded meshes perform very similarly to the standard EC60to30 mesh
- Degraded meshes have slightly higher SSH RMS and EKE
- 0.50 and 0.75 degraded meshes had to be run at smaller timesteps

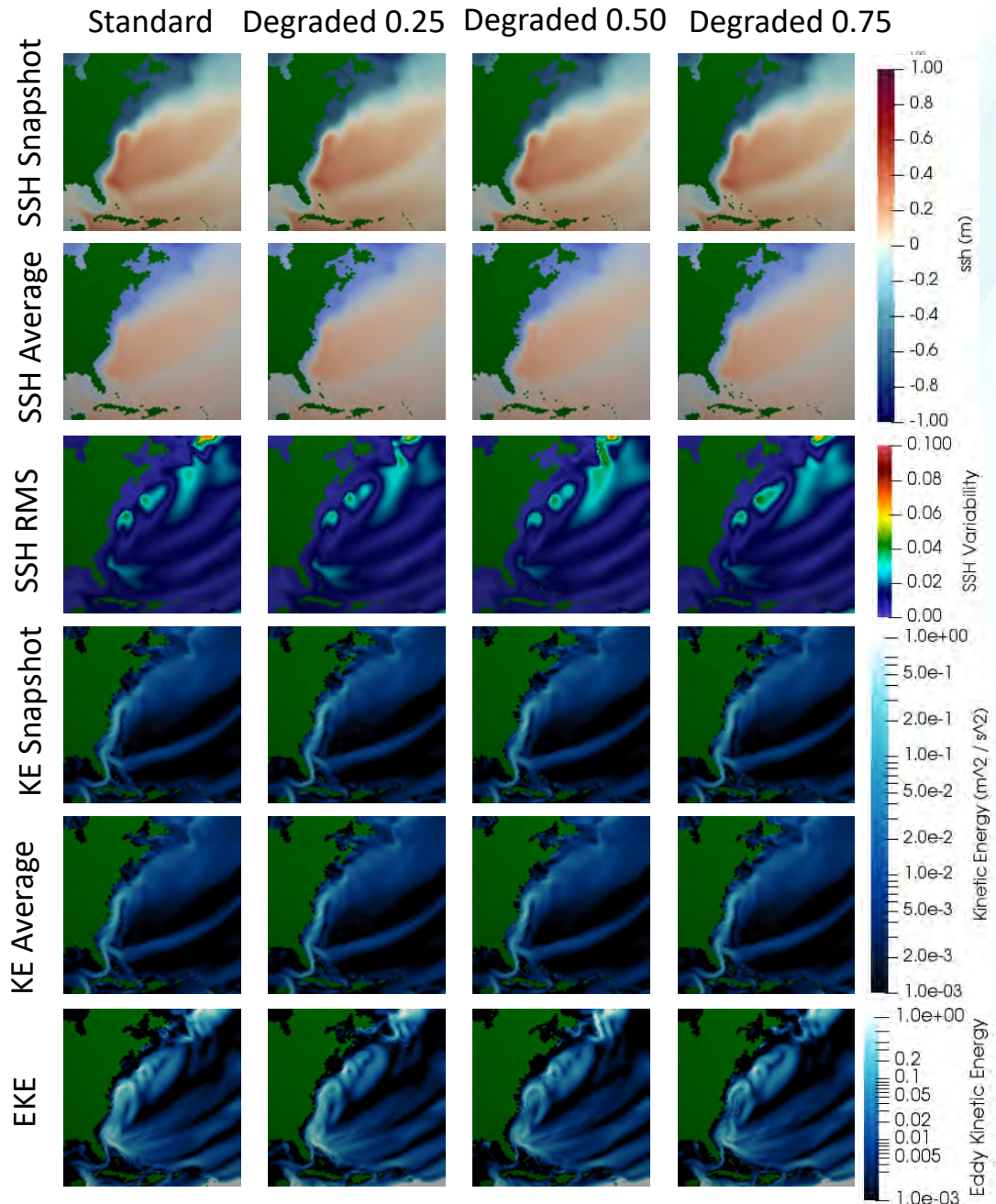

# Study 2: Transition Width

- 10 km transition crashed
- Wider transitions improved dynamics
- Eddies and meanders are affected by narrow transition

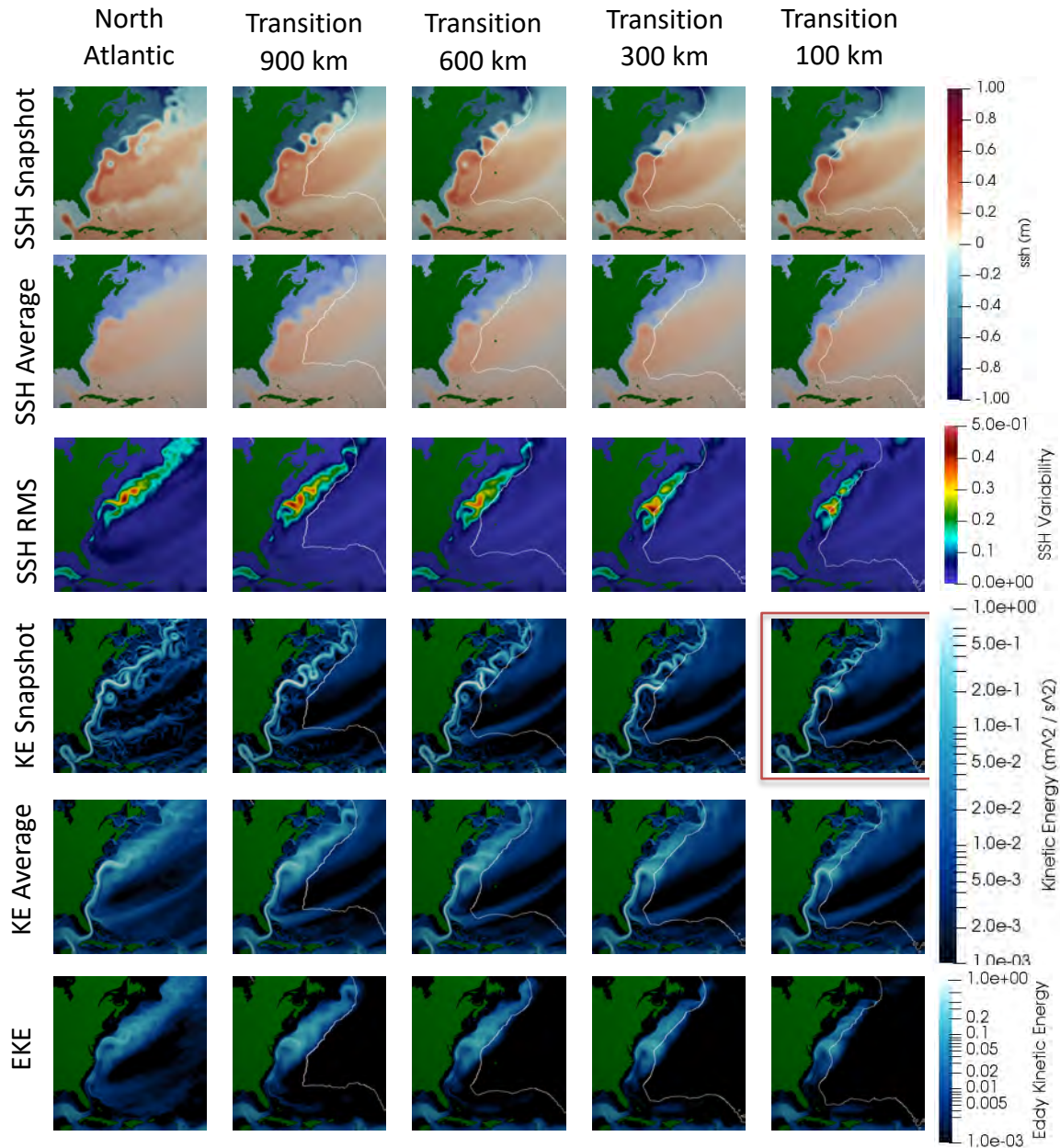
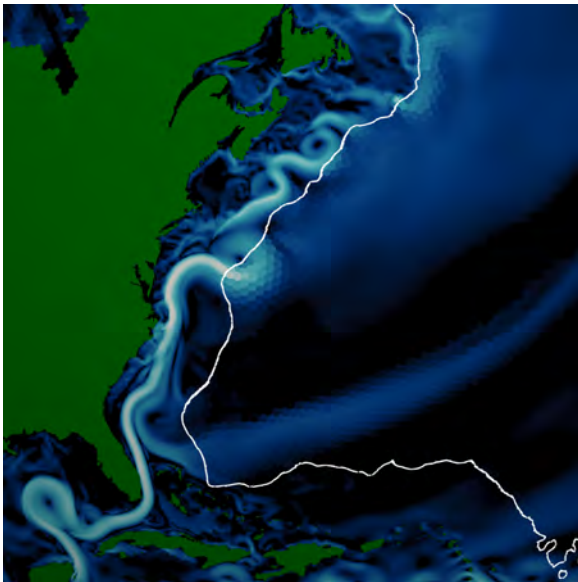



# Study 3: Coastal Resolution

- Improved dynamics with higher coastal resolution
- CUSP8 performs similarly to the North Atlantic mesh

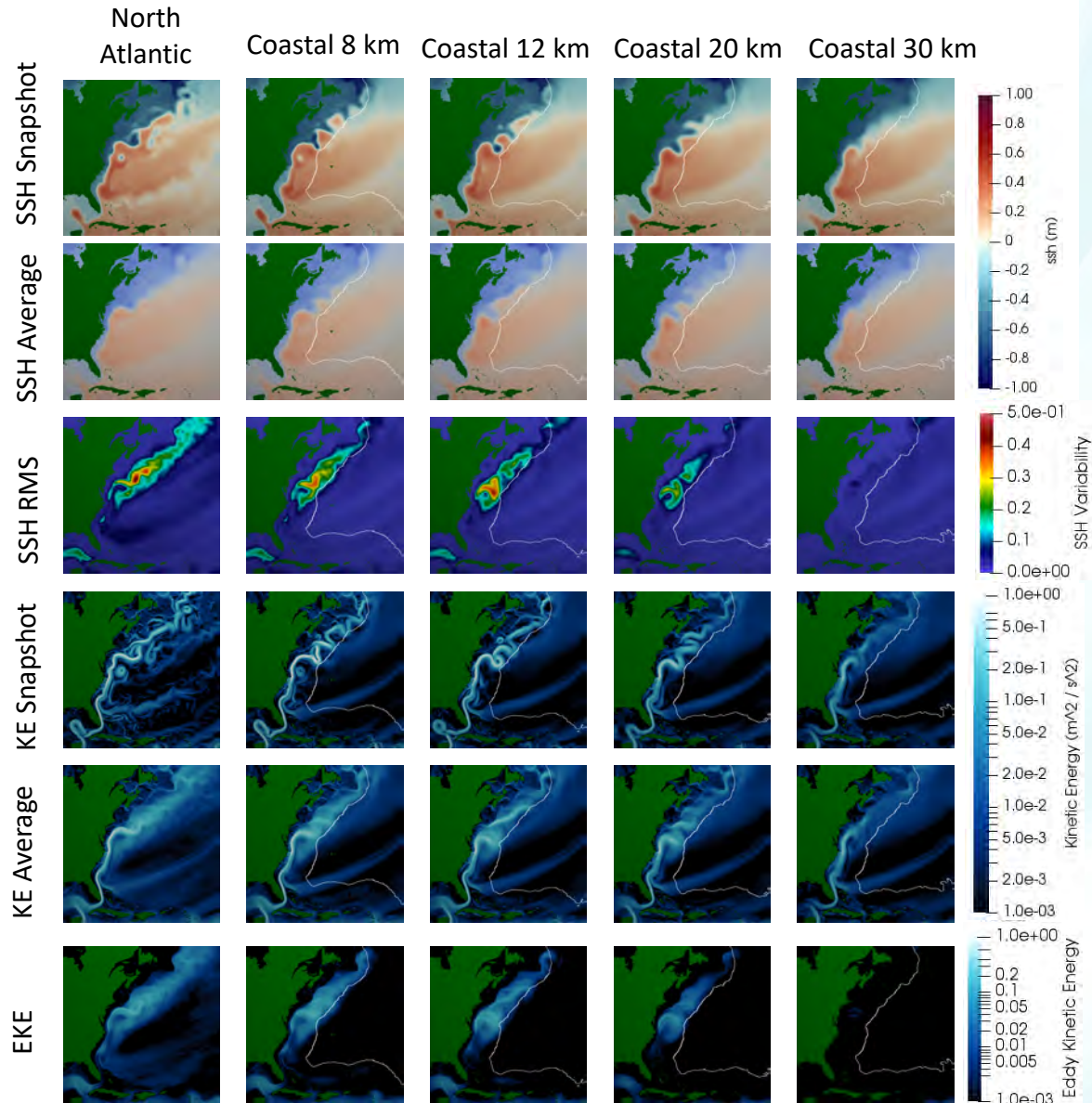
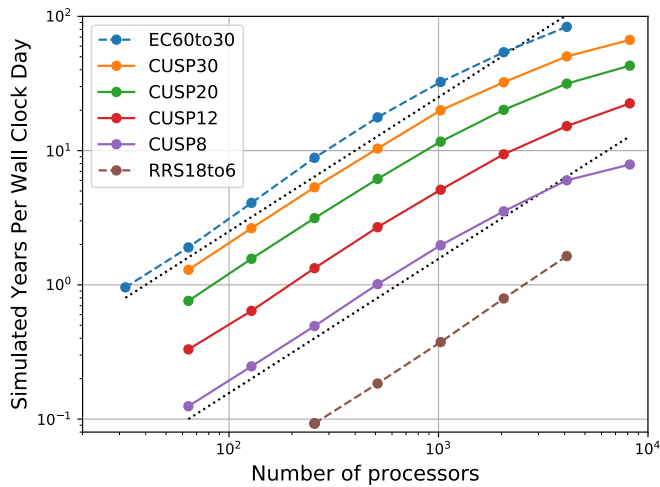



# Conclusion

- Variable resolution JIGSAW meshes are robust
- Cell quality does not appear to be a major source of error
- Care should be taken with placement of transition region
  - Can affect eddy formation and propagation
- Can variable resolution fix your problem?

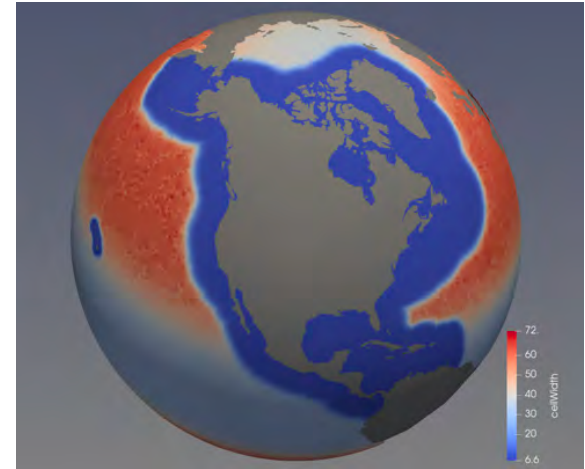

# Regional grid refinement: unexpected effects on Gulf Stream path and Atlantic overturning

**Kevin L. Rosa<sup>1,2\*</sup>, Mark R. Petersen<sup>1</sup>,  
Steven R. Brus<sup>3</sup>, Darren Engwirda<sup>4,5</sup>, Kristin E. Hoch<sup>1</sup>,  
Mathew E. Maltrud<sup>3</sup>, Luke P. Van Roekel<sup>3</sup>, Phillip J. Wolfram<sup>3</sup>,**

<sup>1</sup> Computational Physics and Methods (CCS-2), Los Alamos National Laboratory, Los Alamos, NM, USA

<sup>2</sup> Graduate School of Oceanography, University of Rhode Island, Narragansett, Rhode Island, USA

<sup>3</sup> Fluid Dynamics and Solid Mechanics (T-3), Los Alamos National Laboratory, Los Alamos, NM, USA

<sup>4</sup> NASA Goddard Institute for Space Studies, New York, NY, USA

<sup>5</sup> Center for Climate Systems Research, Columbia University, New York, NY, USA

# Overview

- Testing new coastal-refined variable resolution mesh
- One goal: Hoping to improve Gulf Stream path and strength

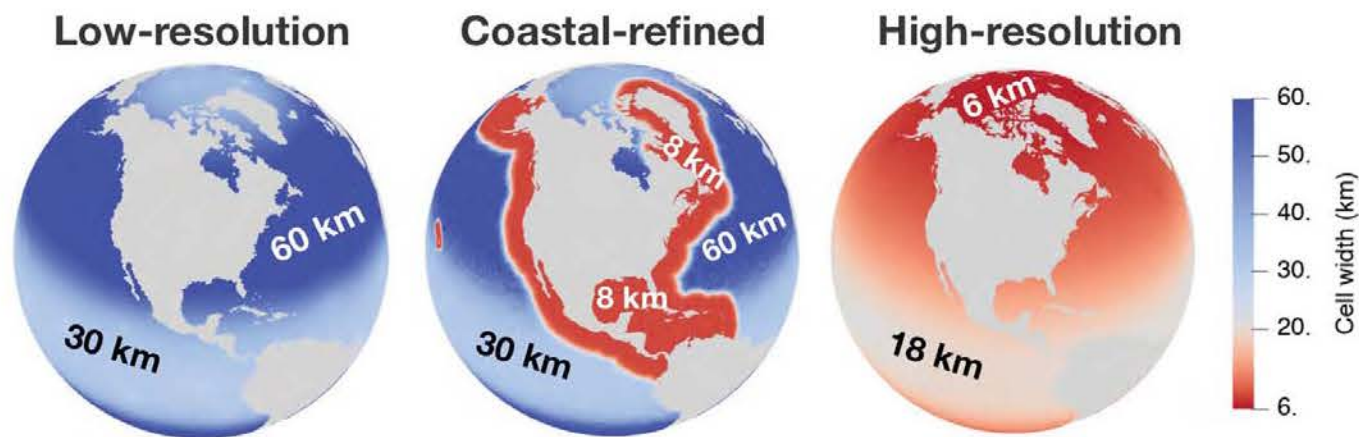



# Overview

- Testing new coastal-refined variable resolution mesh
- One goal: Hoping to improve Gulf Stream path and strength

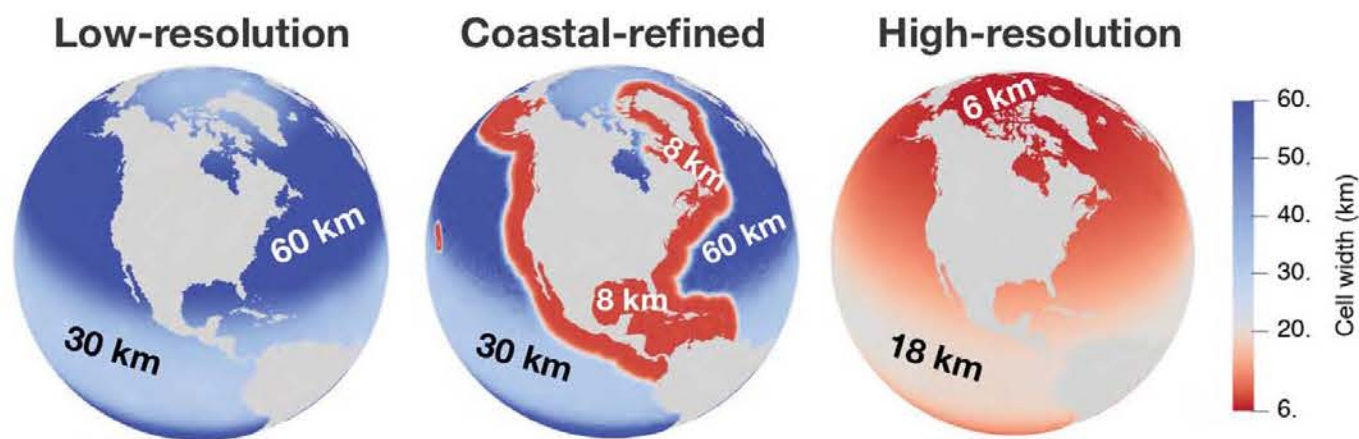

- Showed some improvements (e.g. EKE) but did not fix Gulf Stream bias
- This motivated development of a *new* coastal-refined mesh which shows promising preliminary results

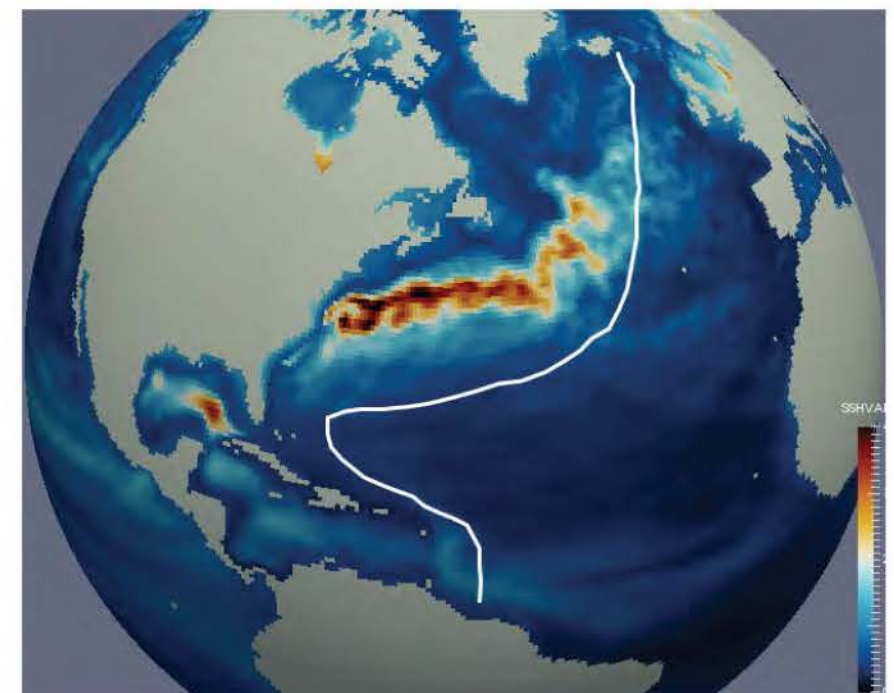

## **Note: A key difference from Kristen's work**

>> Here I'm using realistic atmospheric forcing (CORE v2)

Looking for good agreement with observations and with high-res results from Petersen et al. (2019)

## **Intro/Motivation**

1. Why do we want higher resolution models?
2. What's stopping us from running higher resolution models? And what are some solutions?
3. Ways to design an unstructured mesh



# 1. Why do we want higher resolution models?

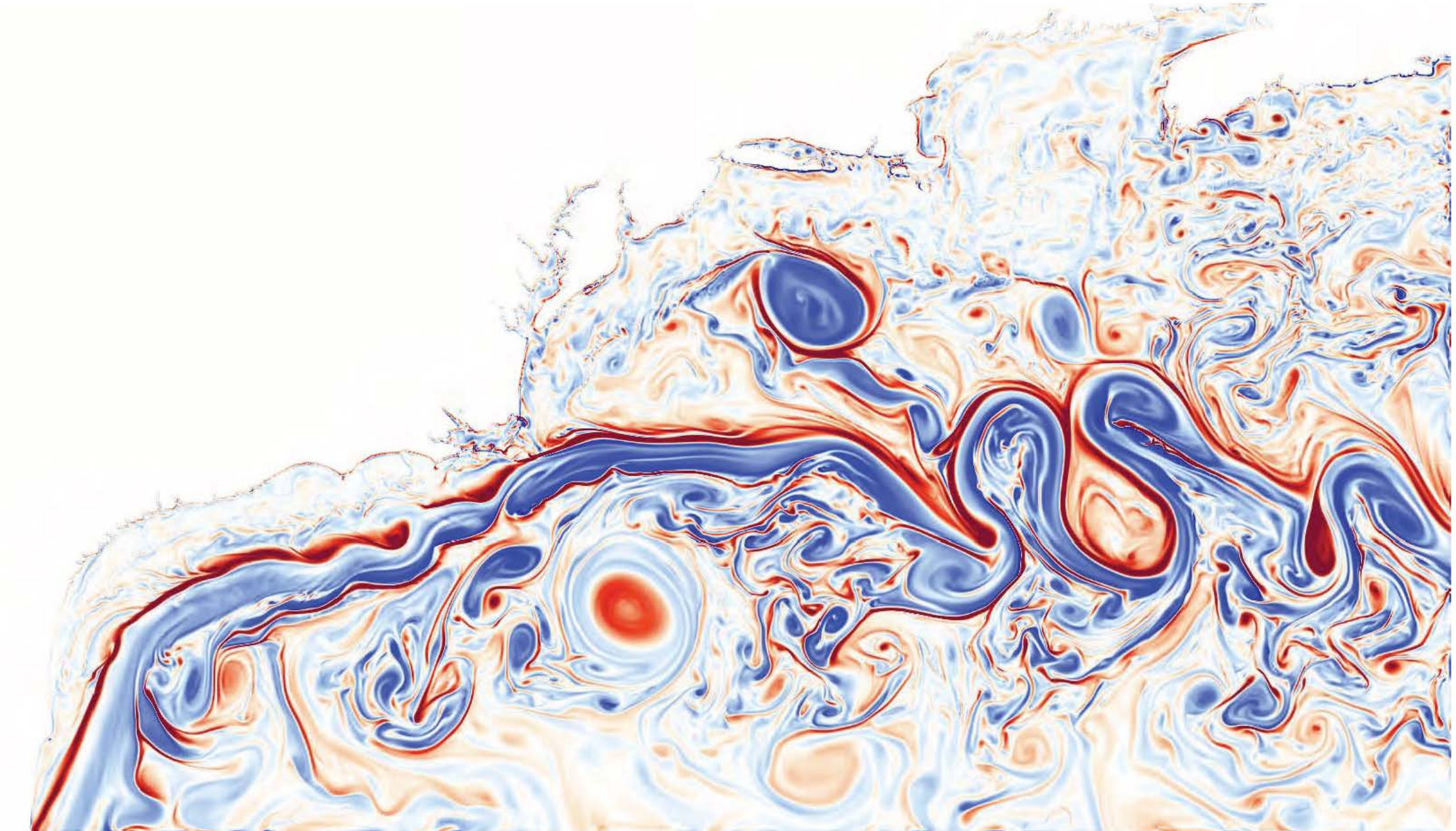

Gulf Stream surface relative vorticity - 1.5 km ROMS simulation.

source: Jonathan Gula, Université de Bretagne Occidentale  
<http://stockage.univ-brest.fr/~gula/movies.html>

## 2. What's stopping us from running higher resolution models?

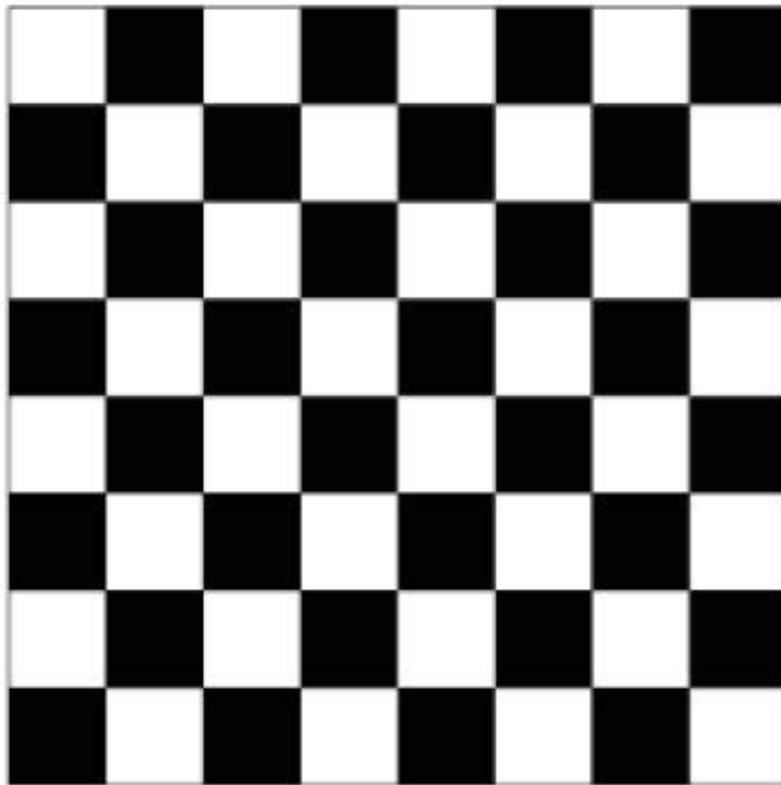

*momentum equation:*

$$\frac{\partial \mathbf{u}}{\partial t} + \eta \mathbf{k} \times \mathbf{u} + w \frac{\partial \mathbf{u}}{\partial z} = -\frac{1}{\rho_0} \nabla p - \frac{\rho g}{\rho_0} \nabla z^{mid} - \nabla K + \mathbf{D}_h^u + \mathbf{D}_v^u + \mathcal{F}^u$$

*thickness equation:*

$$\frac{\partial h}{\partial t} + \nabla \cdot (h \bar{\mathbf{u}}^z) + w|_{z=s^{top}} - w|_{z=s^{bot}} = 0$$

*tracer equation:*

$$\frac{\partial}{\partial t} h \bar{\varphi}^z + \nabla \cdot (h \bar{\varphi} \bar{\mathbf{u}}^z) + \varphi w|_{z=s^{top}} - \varphi w|_{z=s^{bot}} = D_h^\varphi + D_v^\varphi + \mathcal{F}^\varphi$$

*hydrostatic condition:*

$$p(x, y, z) = p^s(x, y) + \int_z^{z^s} \rho g dz'$$

*equation of state:*

$$\rho = f_{eos}(\Theta, S, p)$$

Primitive Equations (incompressible hydrostatic Boussinesq)  
MPAS-Ocean Model User's Guide 2.0 (2013)

Chessboard graphic:

<http://mathworld.wolfram.com/Chessboard.html>



2. What's stopping us from running higher resolution models?

**Low-resolution ocean**

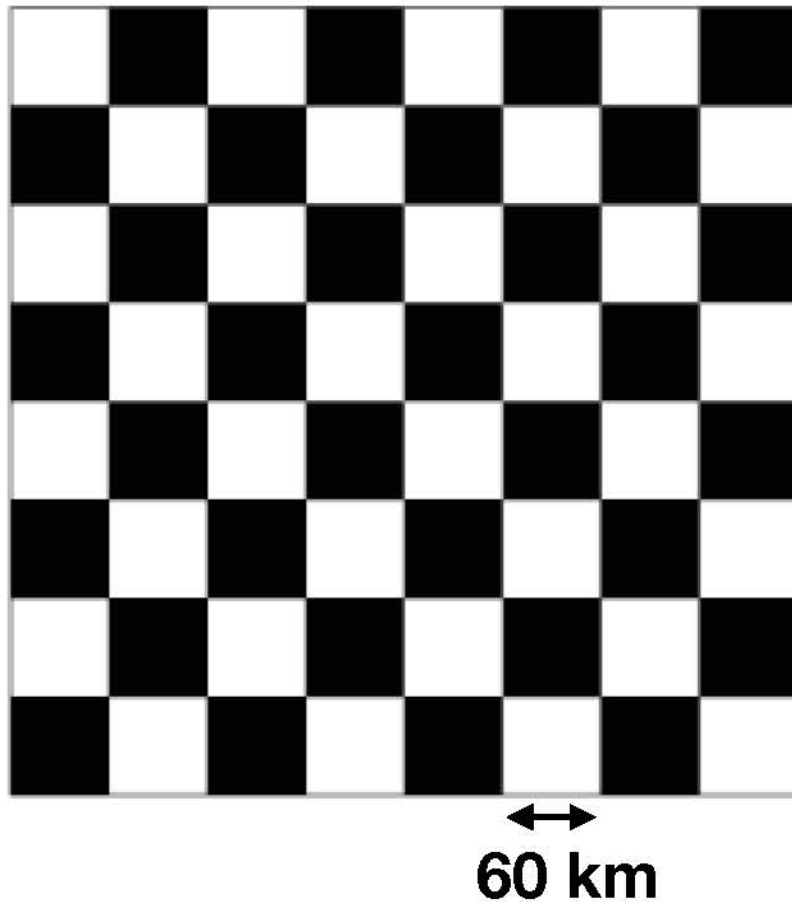

**4x higher resolution**

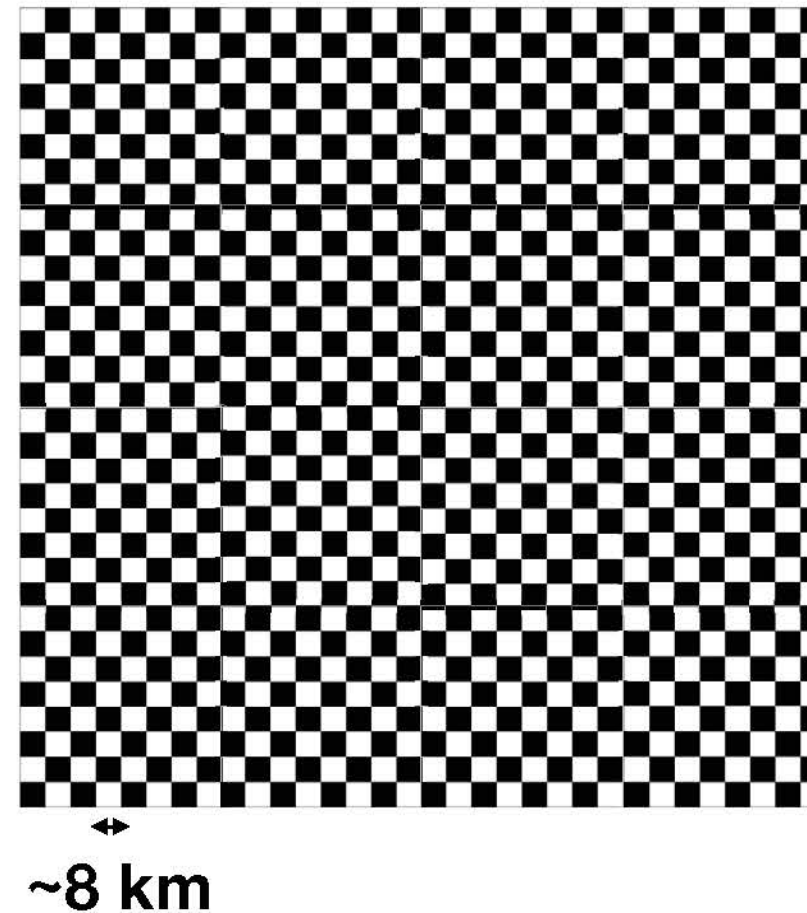

16x more cells , 4x smaller timestep -> **64x higher computational cost**

>> A low-resolution simulation that runs in a day now takes 2 months to run



## 2. What's stopping us from running higher resolution models?

**Table 1.** Setup and performance

	Low-resolution	Coastal-refined	High-resolution
Mesh name	EC60to30	CUSP8	RRS18to6
Horizontal Grid Cells (ocean)	235k	645k	3.69 mil
Cell Size: min-max	30-60 km	8-60 km	6-18 km
Vertical Layers	60	60	80
Time step	30 min	10 min	6 min
Simulated years per day	13.18	4.55	0.77
Total cores (ocean + sea ice + coupler)	960	2160	3600
Million CPU hours per century	0.17 <sup>a</sup>	1.1 <sup>b</sup>	11.9 <sup>b</sup>
Cost vs. low-resolution	×1.0	×6.5	×65.9

<sup>a</sup>compy mcnodface

<sup>b</sup>blues

2. What's stopping us from running higher resolution models?

### Regional resolution refinement

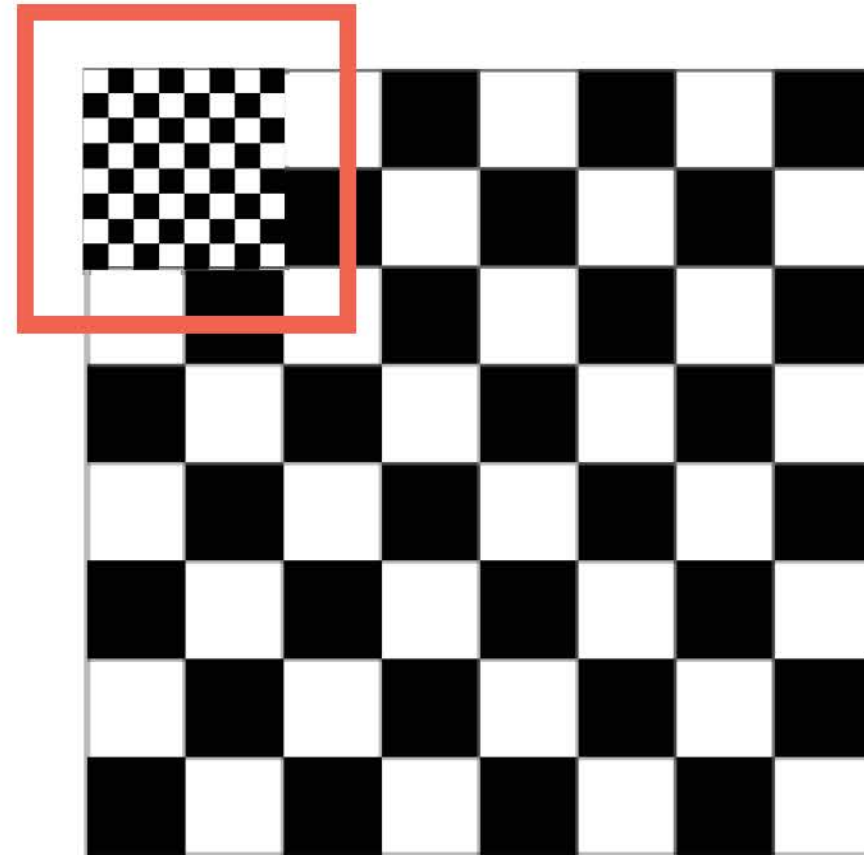
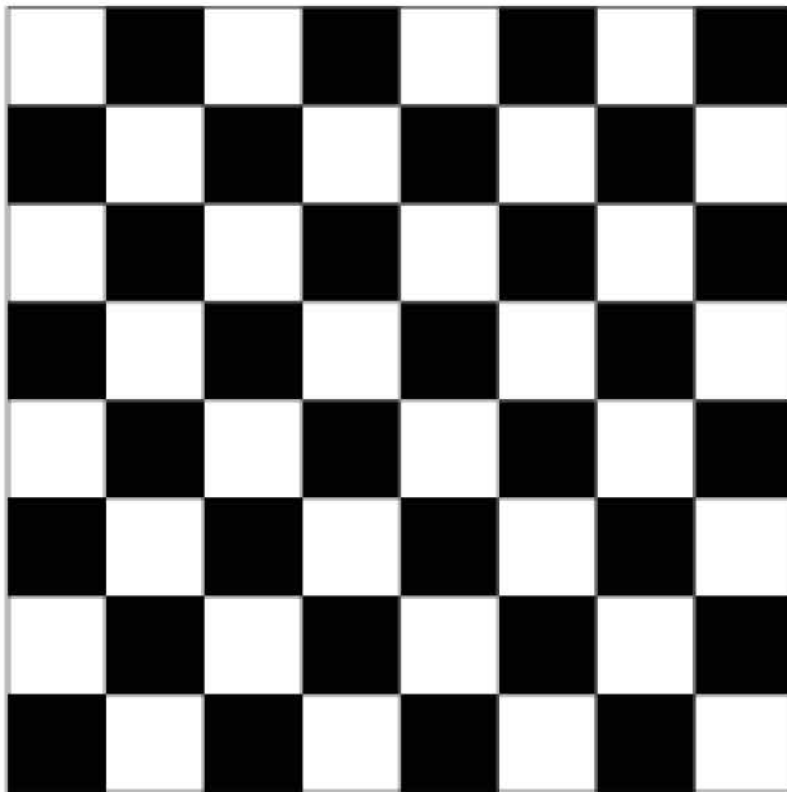

## 2. What's stopping us from running higher resolution models?

**Table 1.** Setup and performance

	Low-resolution	Coastal-refined	High-resolution
Mesh name	EC60to30	CUSP8	RRS18to6
Horizontal Grid Cells (ocean)	235k	645k	3.69 mil
Cell Size: min-max	30-60 km	8-60 km	6-18 km
Vertical Layers	60	60	80
Time step	30 min	10 min	6 min
Simulated years per day	13.18	4.55	0.77
Total cores (ocean + sea ice + coupler)	960	2160	3600
Million CPU hours per century	0.17 <sup>a</sup>	1.1	11.9 <sup>b</sup>
Cost vs. low-resolution	×1.0	×6.5	×65.9

<sup>a</sup>compy mcnodface  
<sup>b</sup>blues

### 3. Ways to design an unstructured mesh

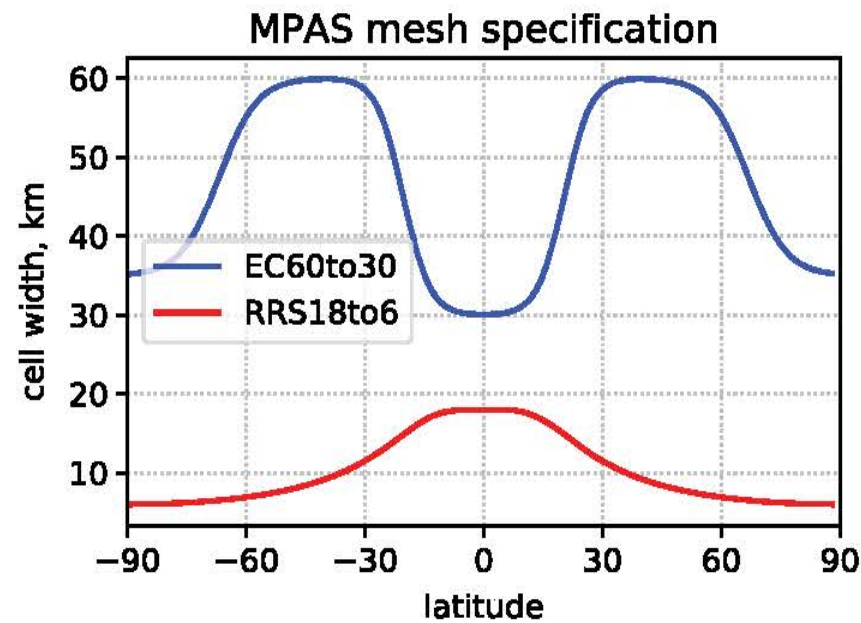

MPAS-Ocean standard meshes

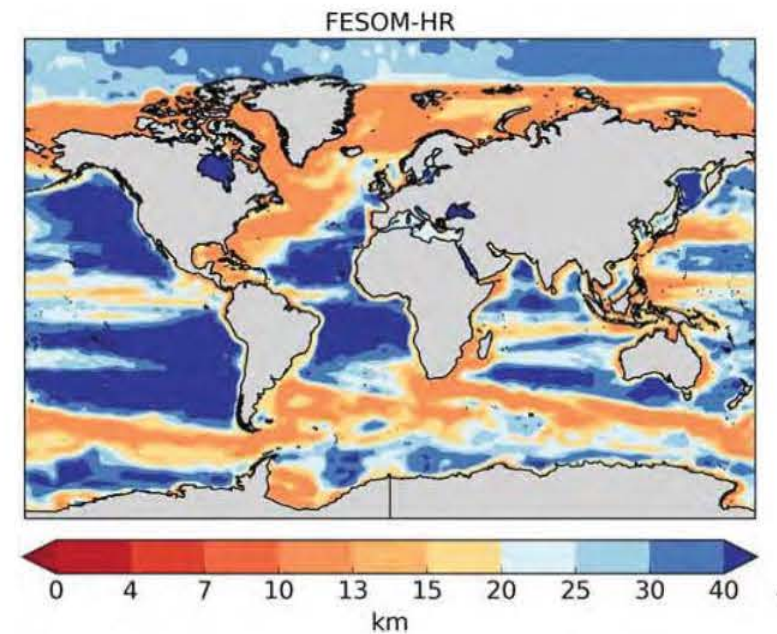

Scaled by observed SSH variability  
Sein et al. (2016)

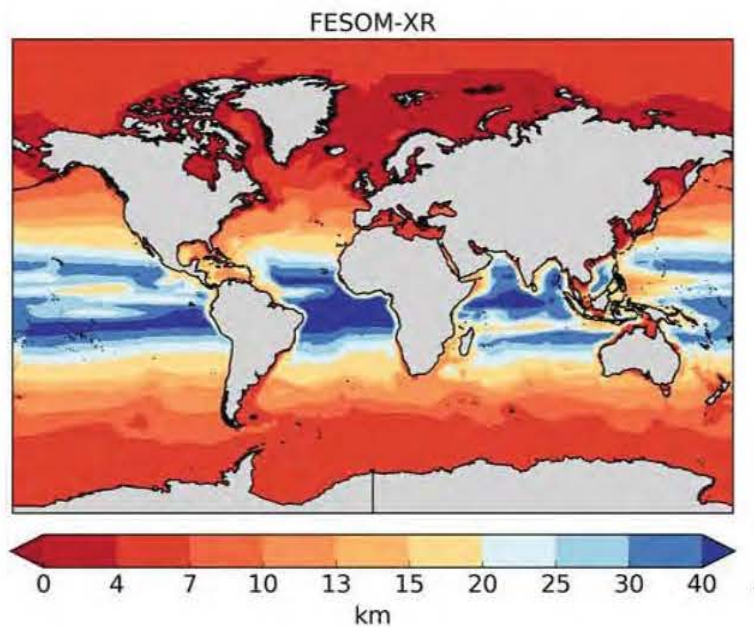

Scaled by Rossby Radius  
Sein et al. (2017)

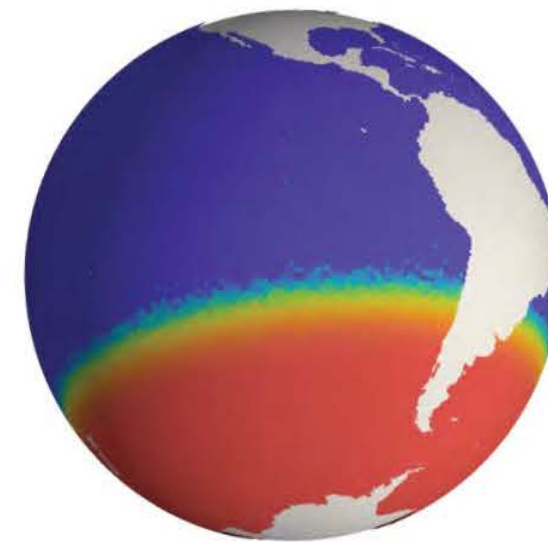

60 km global, 15 km Southern Ocean  
Rosa et al. (2018) AGU Poster



### 3. Ways to design an unstructured mesh

**Low-resolution**



**Coastal-refined**



**High-resolution**

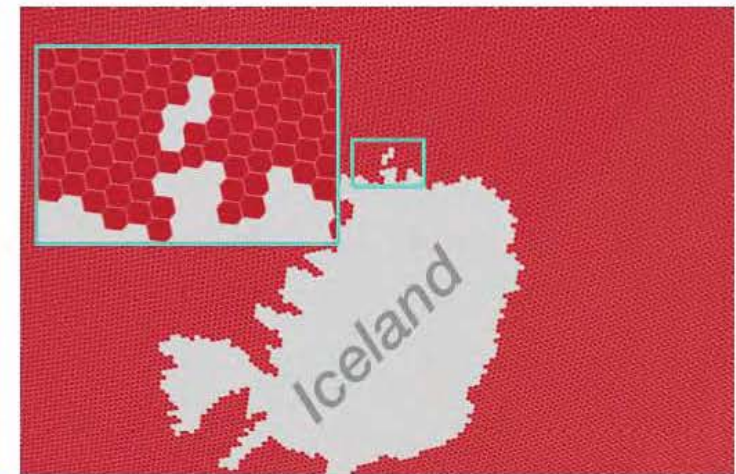
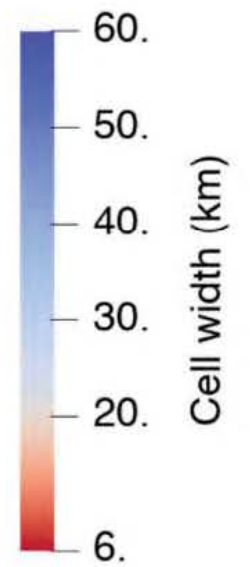

Cost:

x1

x7

x66

# Results part 1: California Upwelling

## Motivation:

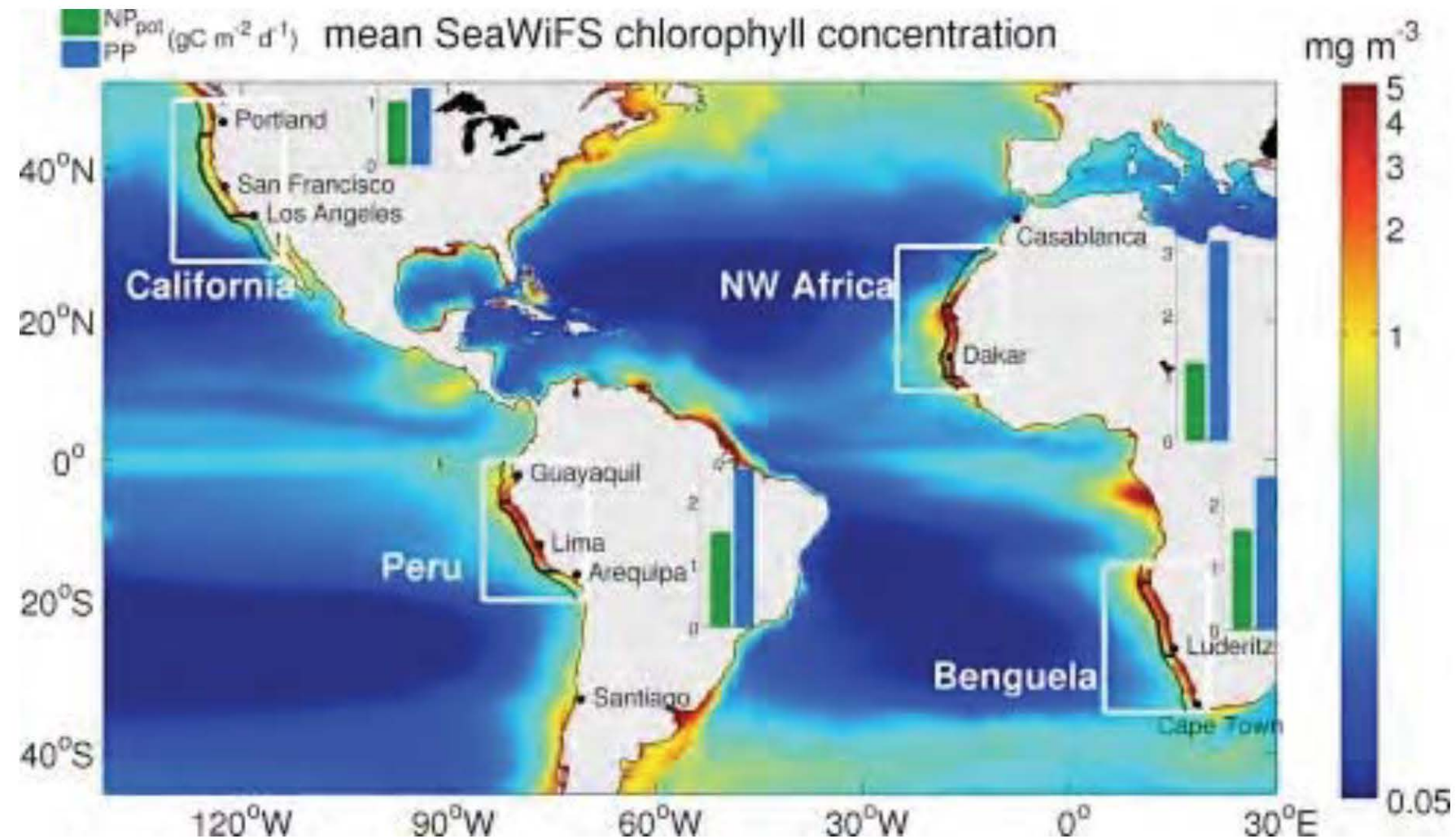

Messié and Chavez (2014)

<1% of ocean area supports:

- \* 5% of marine primary production (Carr, 2002) and
- \* 20% of fisheries catch (Chavez and Messié, 2009)



# Results part 1: California Upwelling

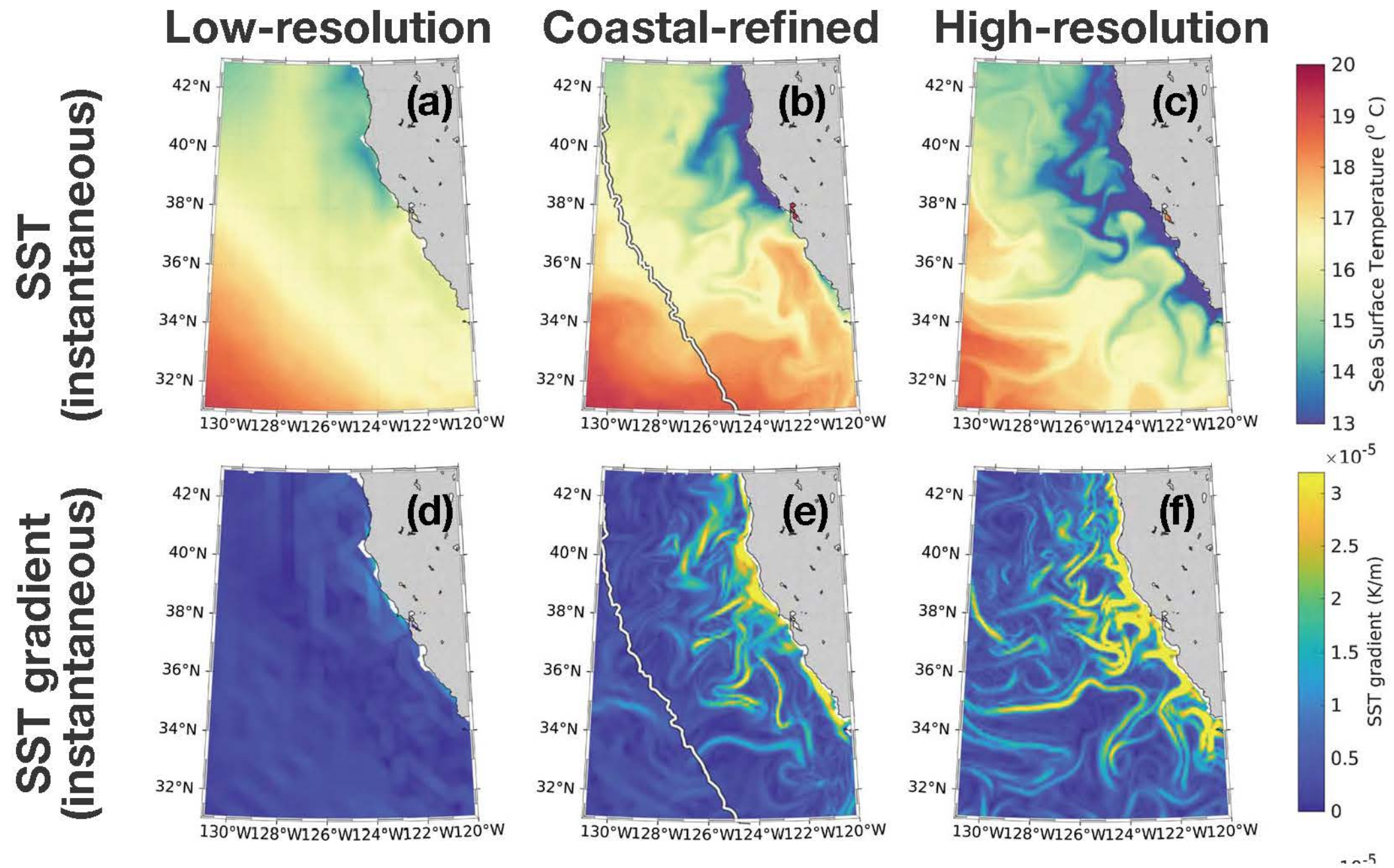



# Results part 1: California Upwelling

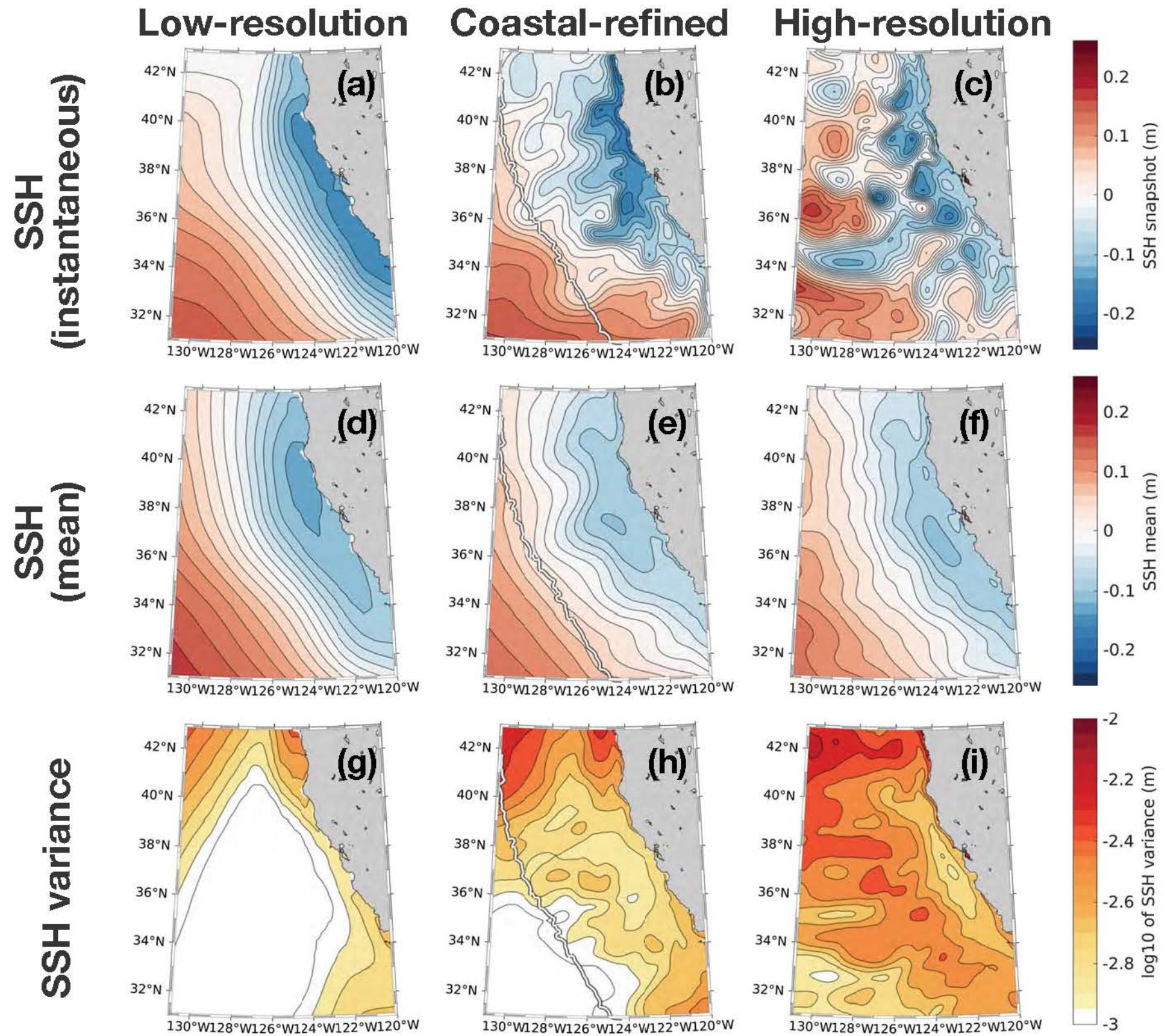



# Results part 1: California Upwelling

## Wavenumber power spectral analysis: Quantifying what we saw by eye

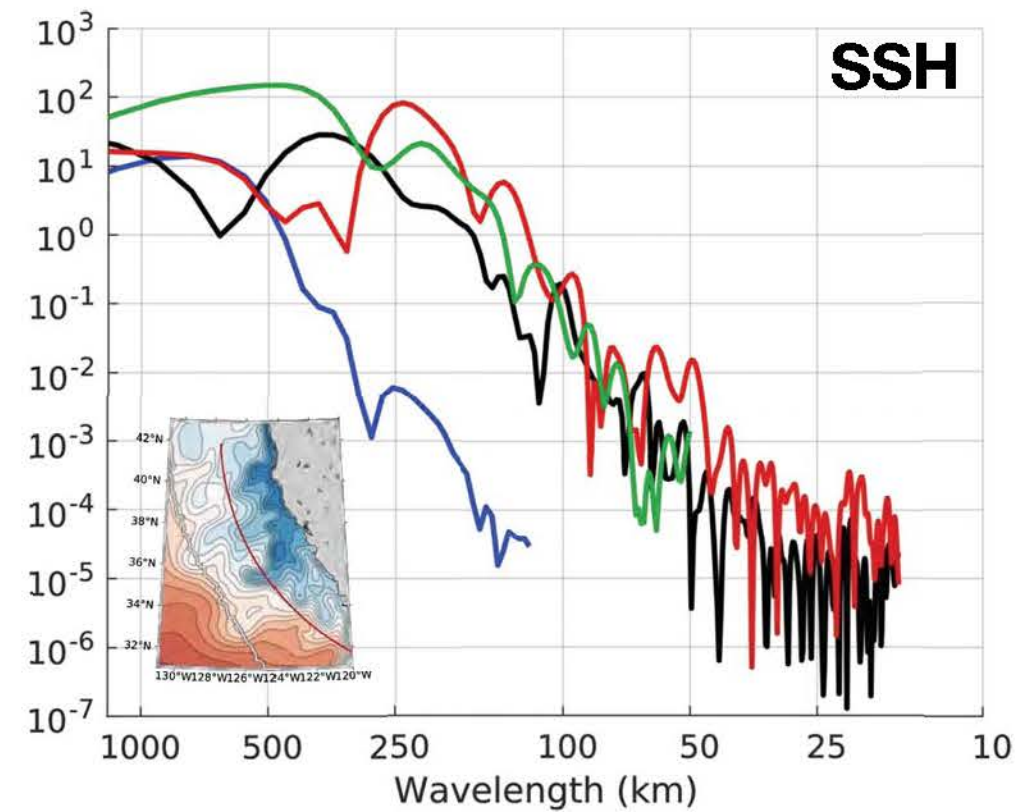
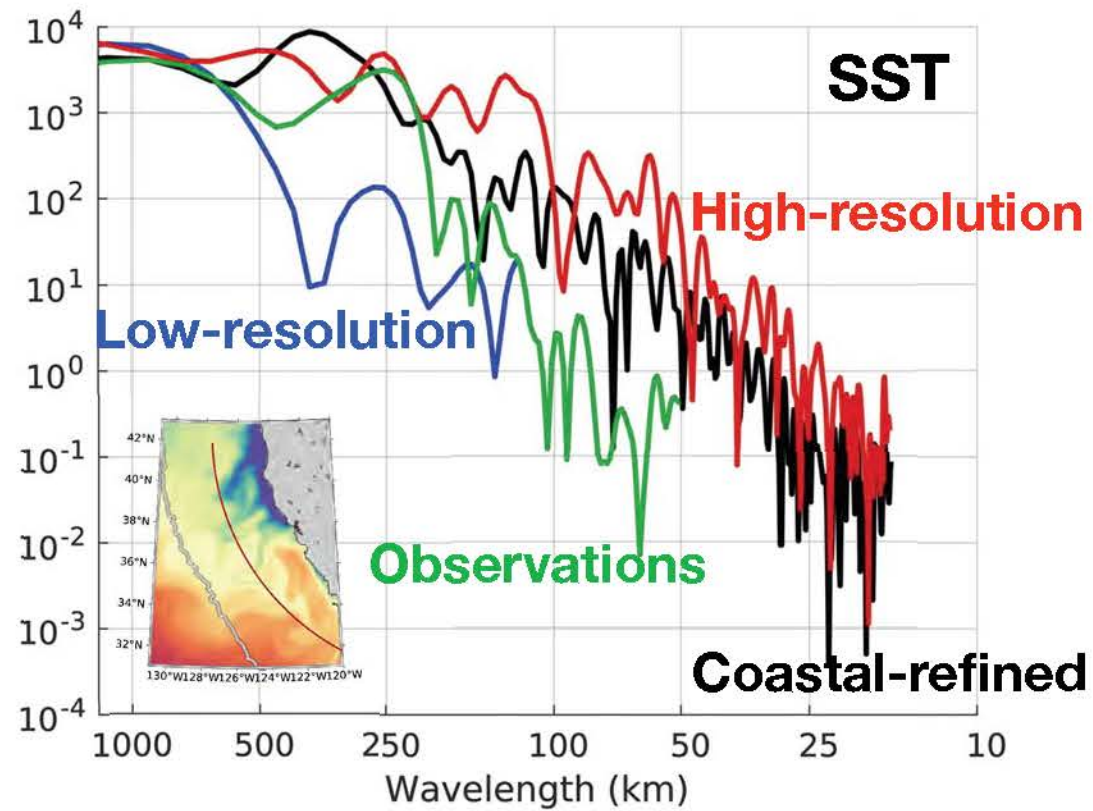

## Results part 2: Western boundary current

### Motivations:

- \* Path: Low-resolution MPAS-O (and many other climate models) has unrealistic Gulf Stream (GS) path.

>> Large SST bias in western North Atlantic

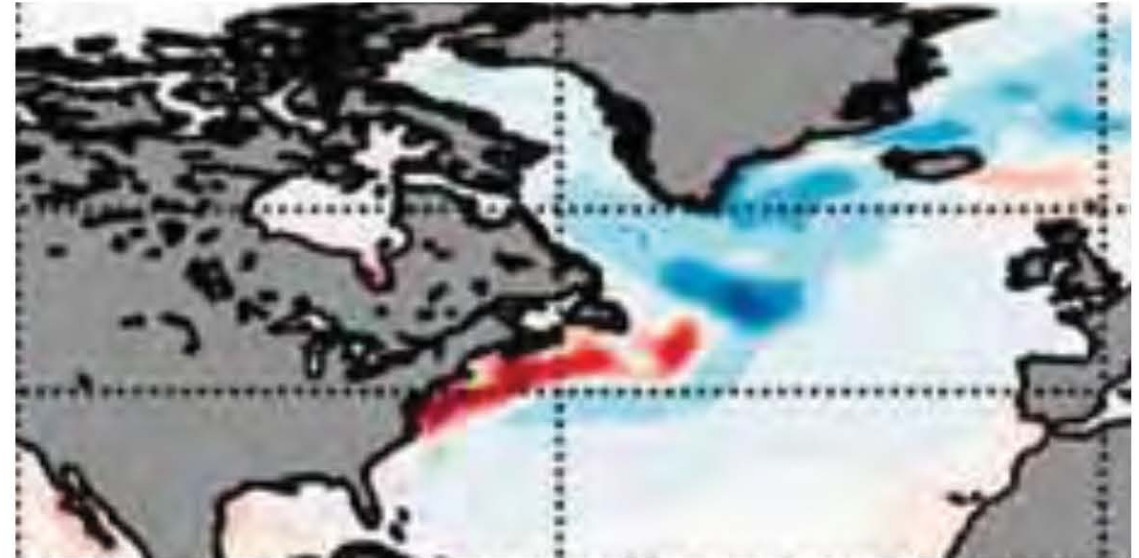

SST bias: Low-res model - Observations  
Petersen et al. (2019)

### Florida-Bahamas Transport Petersen et al. (2019)

EC60to30	RRS18to6	Observations
17.6 Sv	30.1 Sv	31.5 Sv

- \* Transport: Low-res GS transport is much weaker than high-res and observations.



# Results part 2: Western boundary current

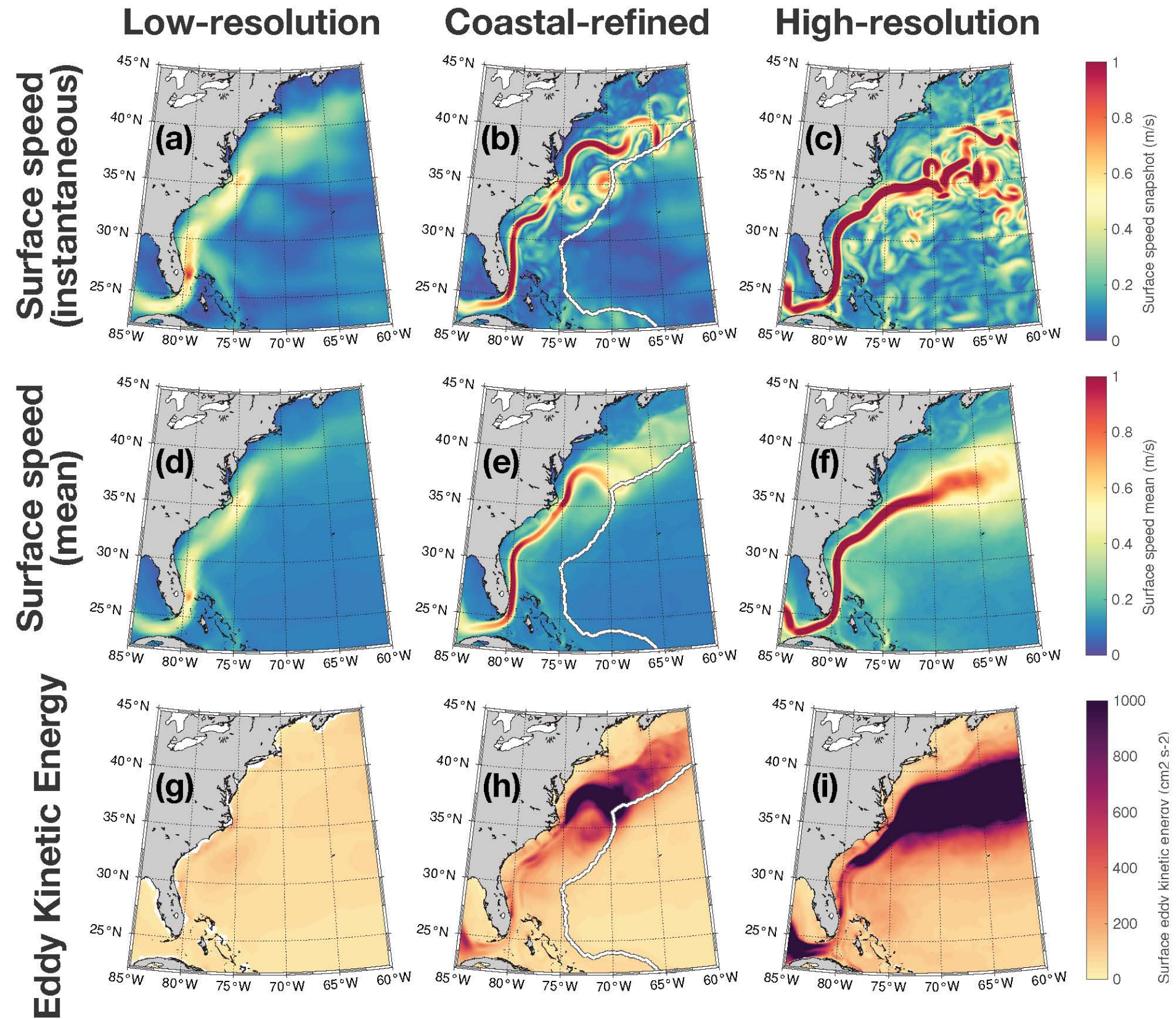



# Results part 2: Western boundary current

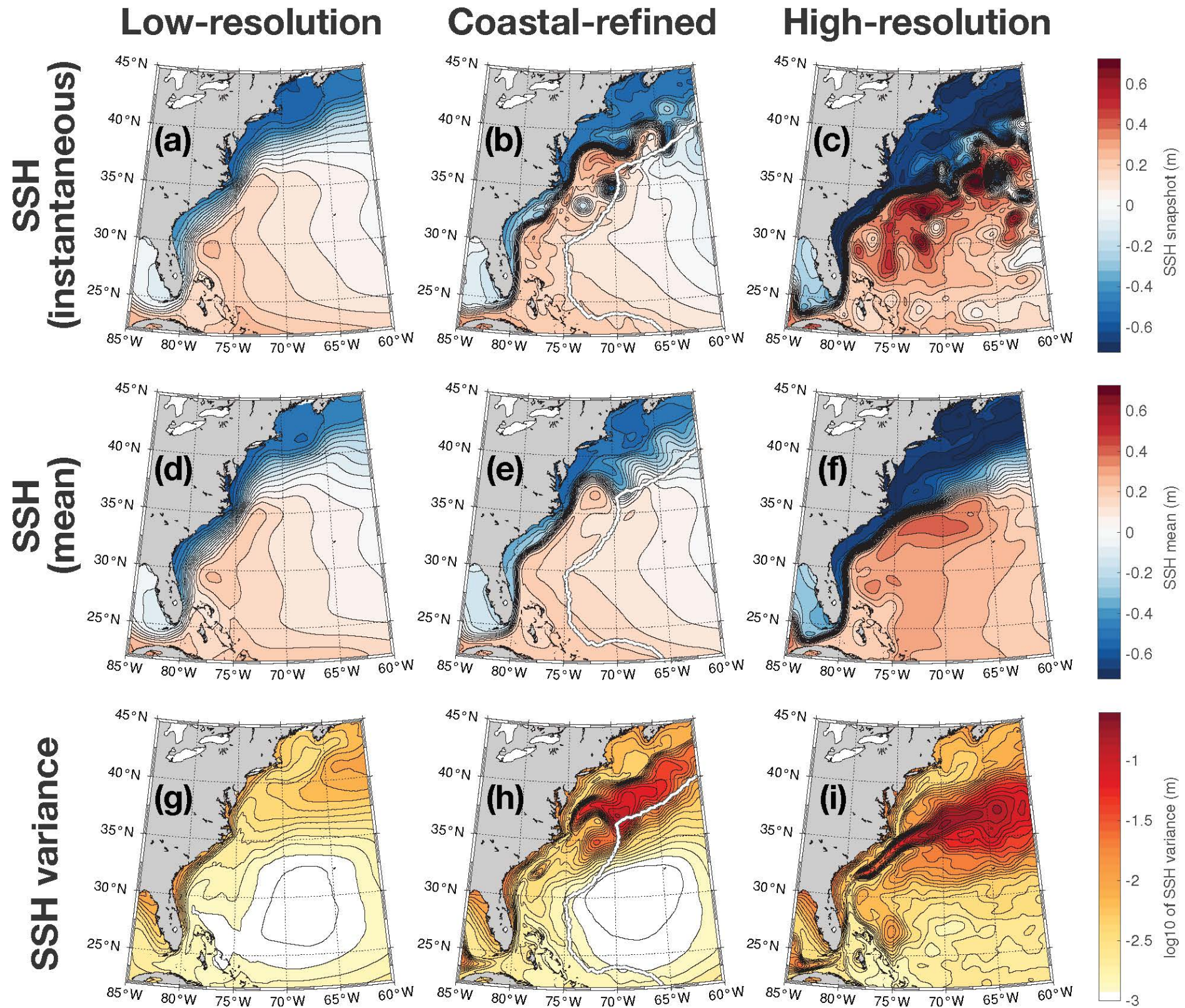



## Results part 2: Western boundary current

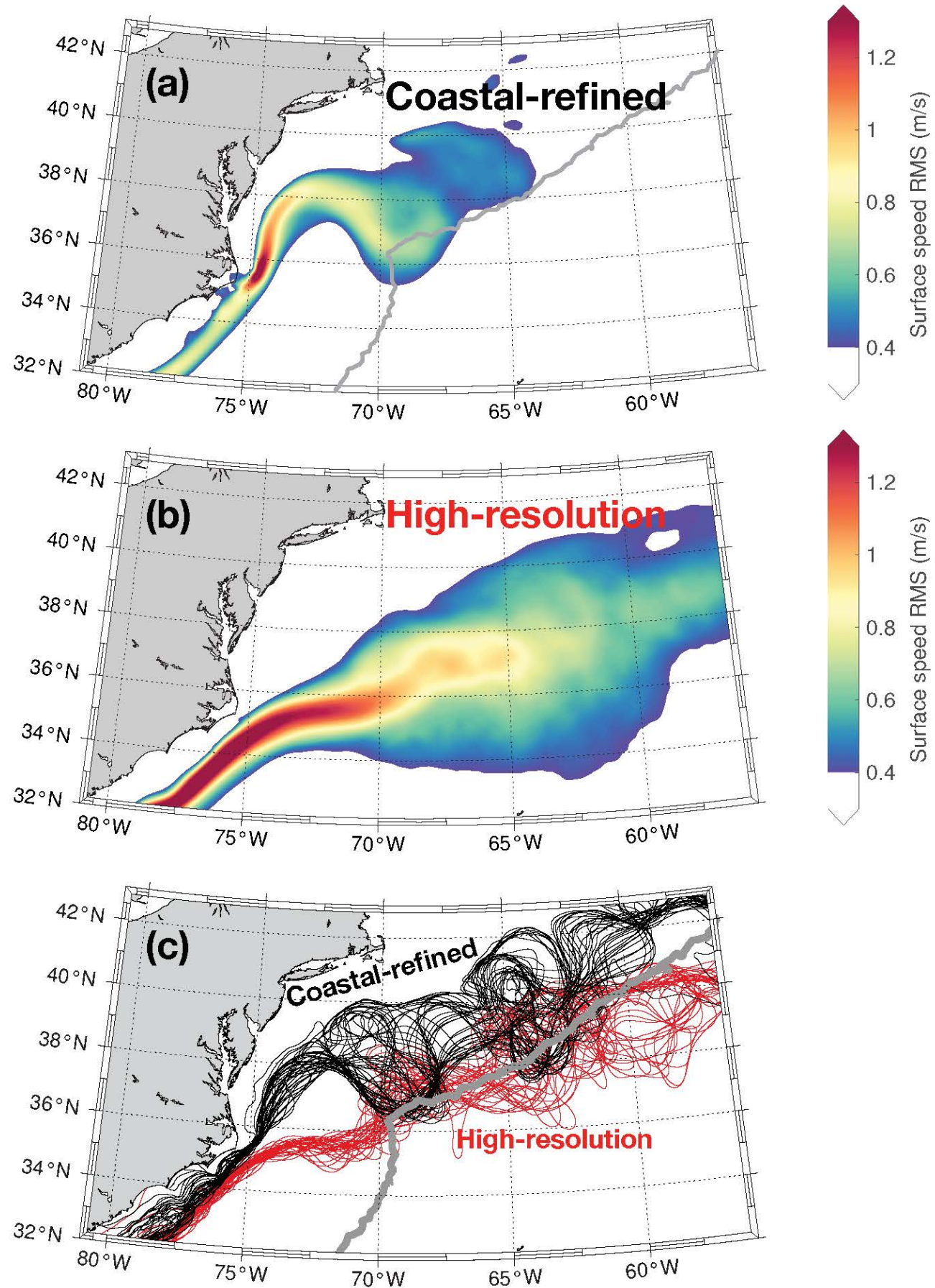

## Results part 2: Western boundary current

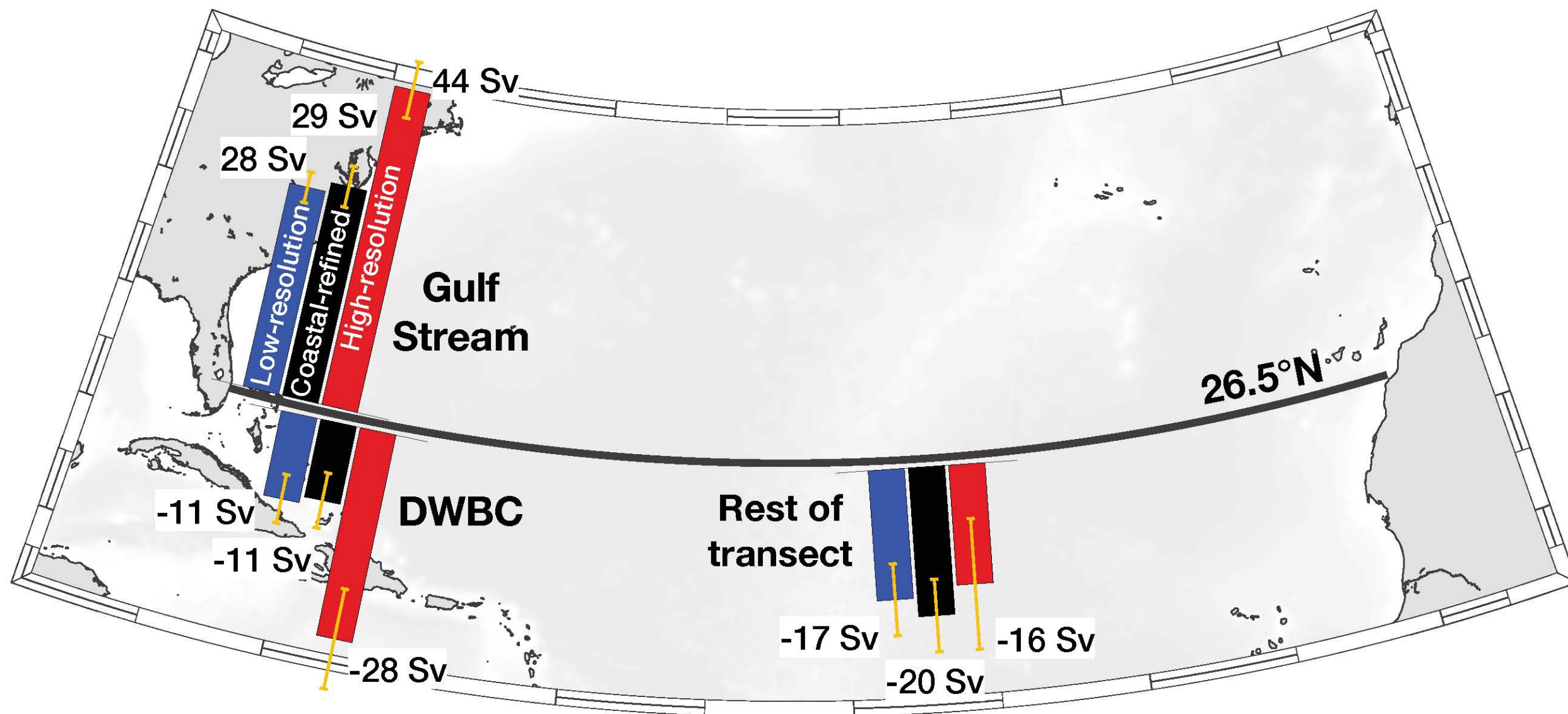

*Going to build this figure up piece by piece*

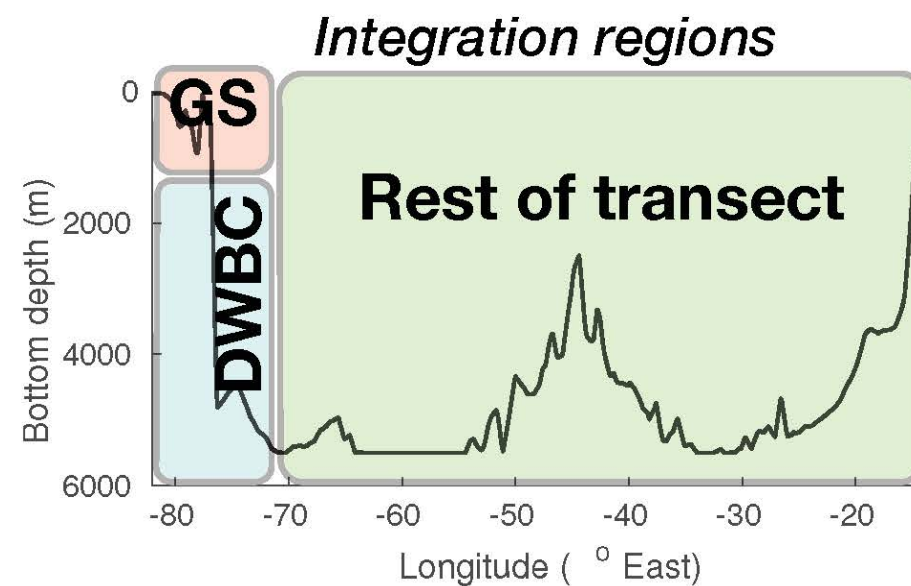



## Results part 2: Western boundary current

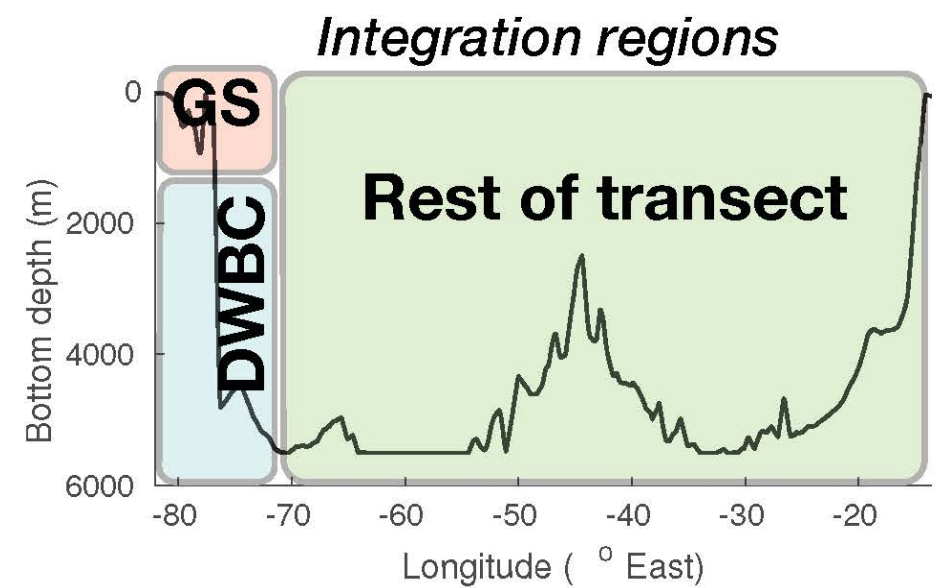
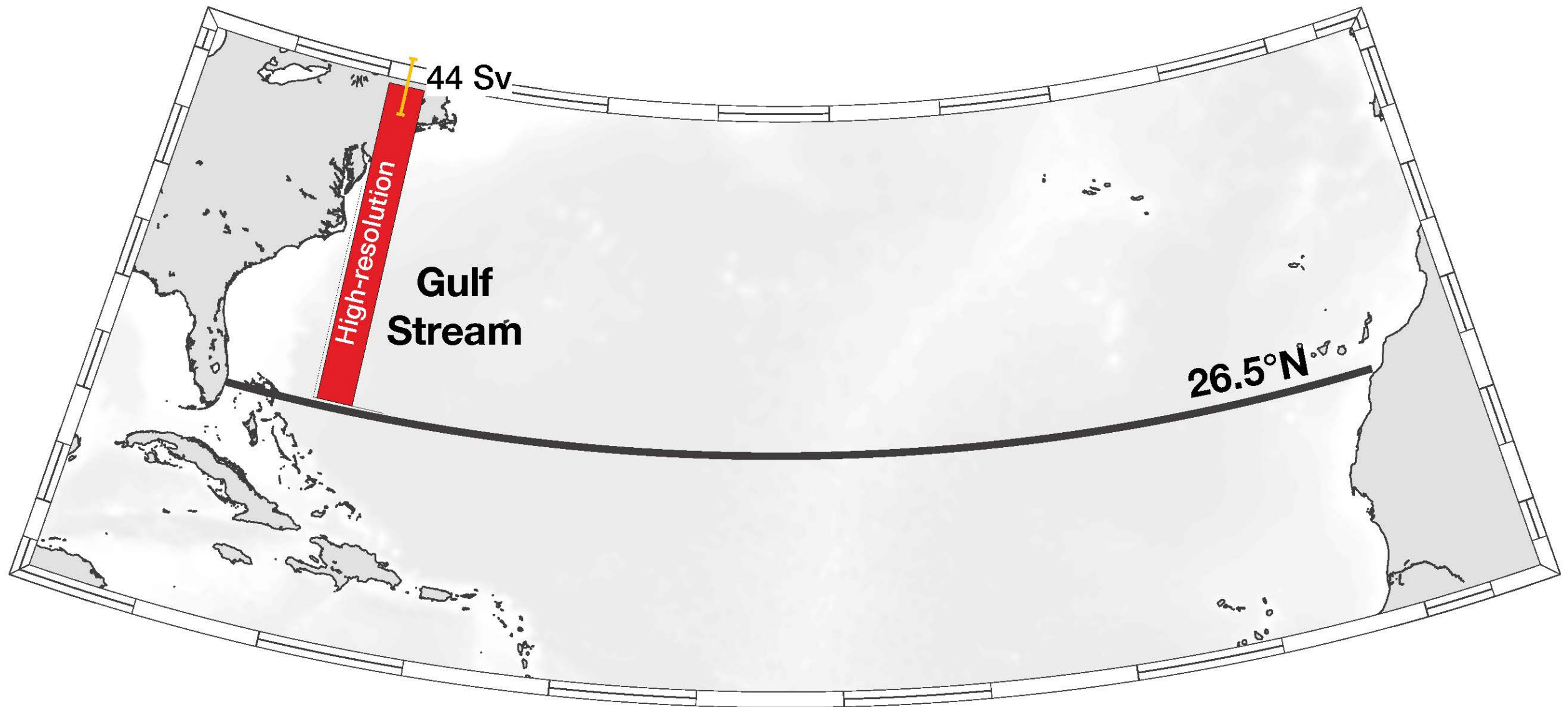

## Results part 2: Western boundary current

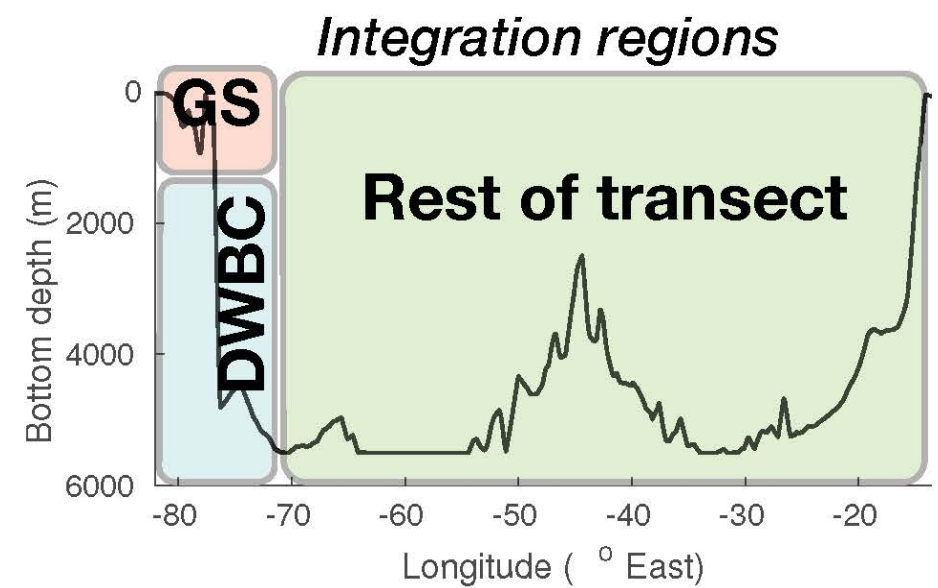
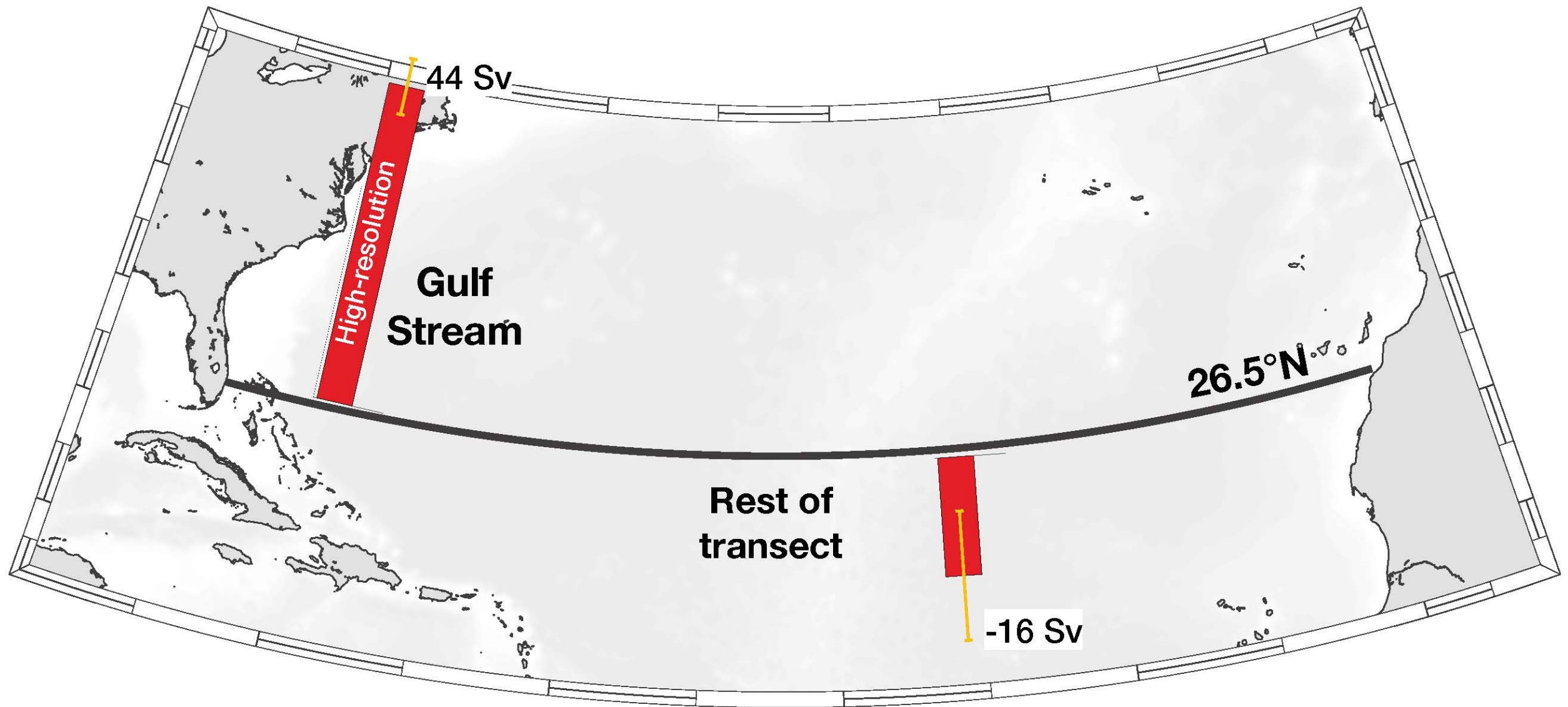

## Results part 2: Western boundary current

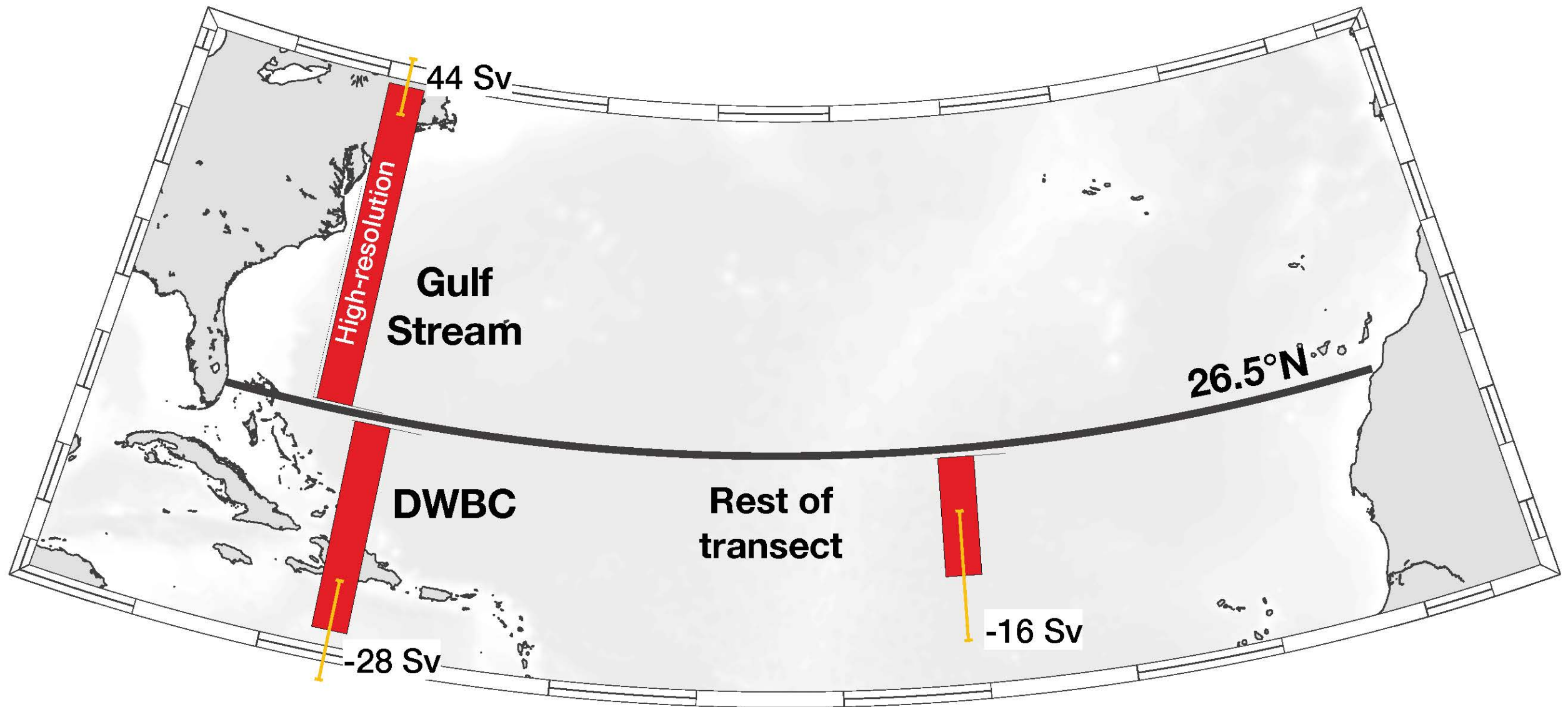

44
- 28
- 16
—
= 0

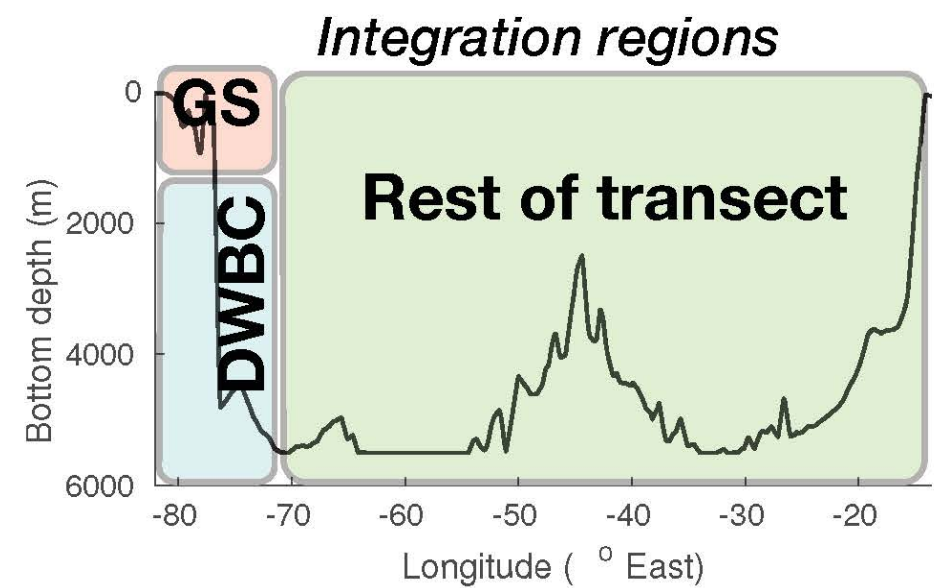



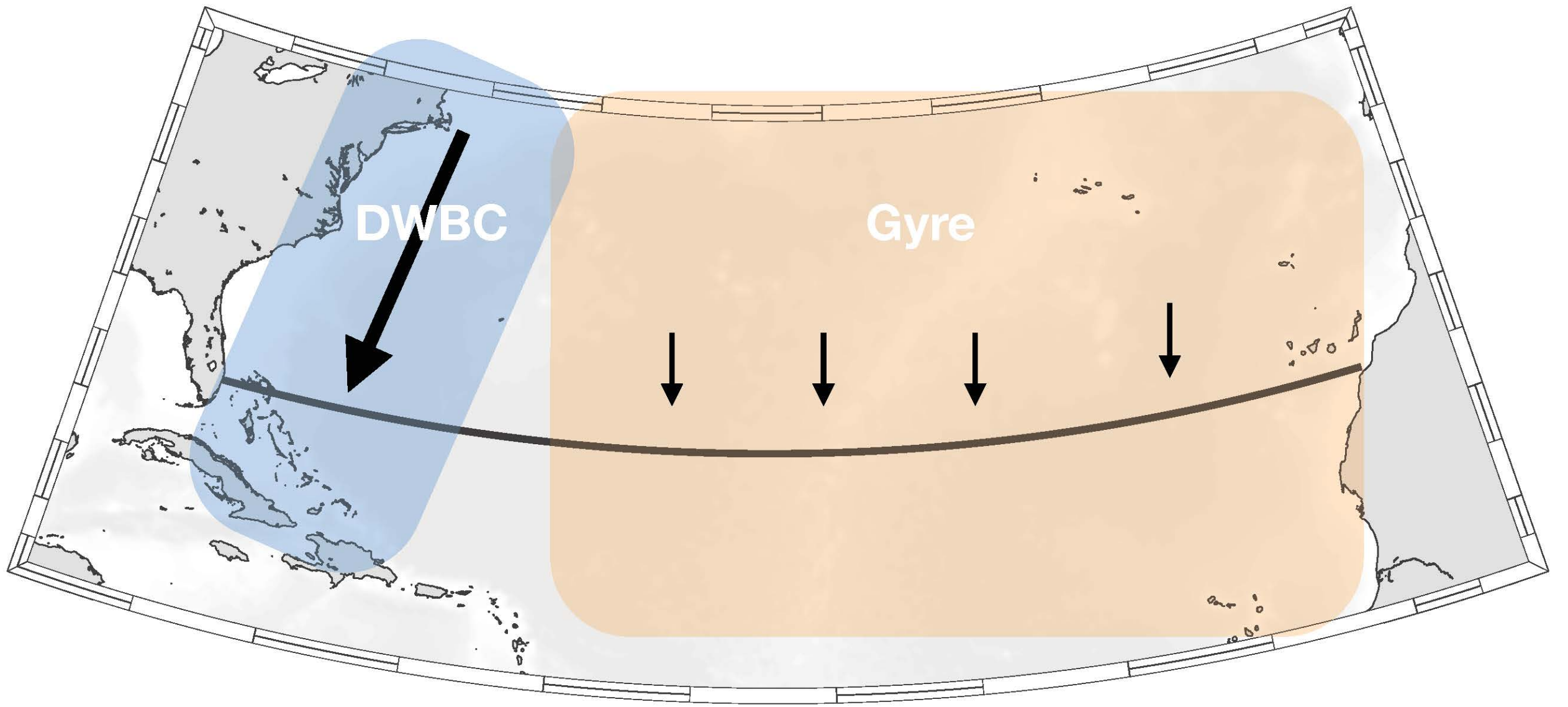

# 1. Deep Western Boundary Current

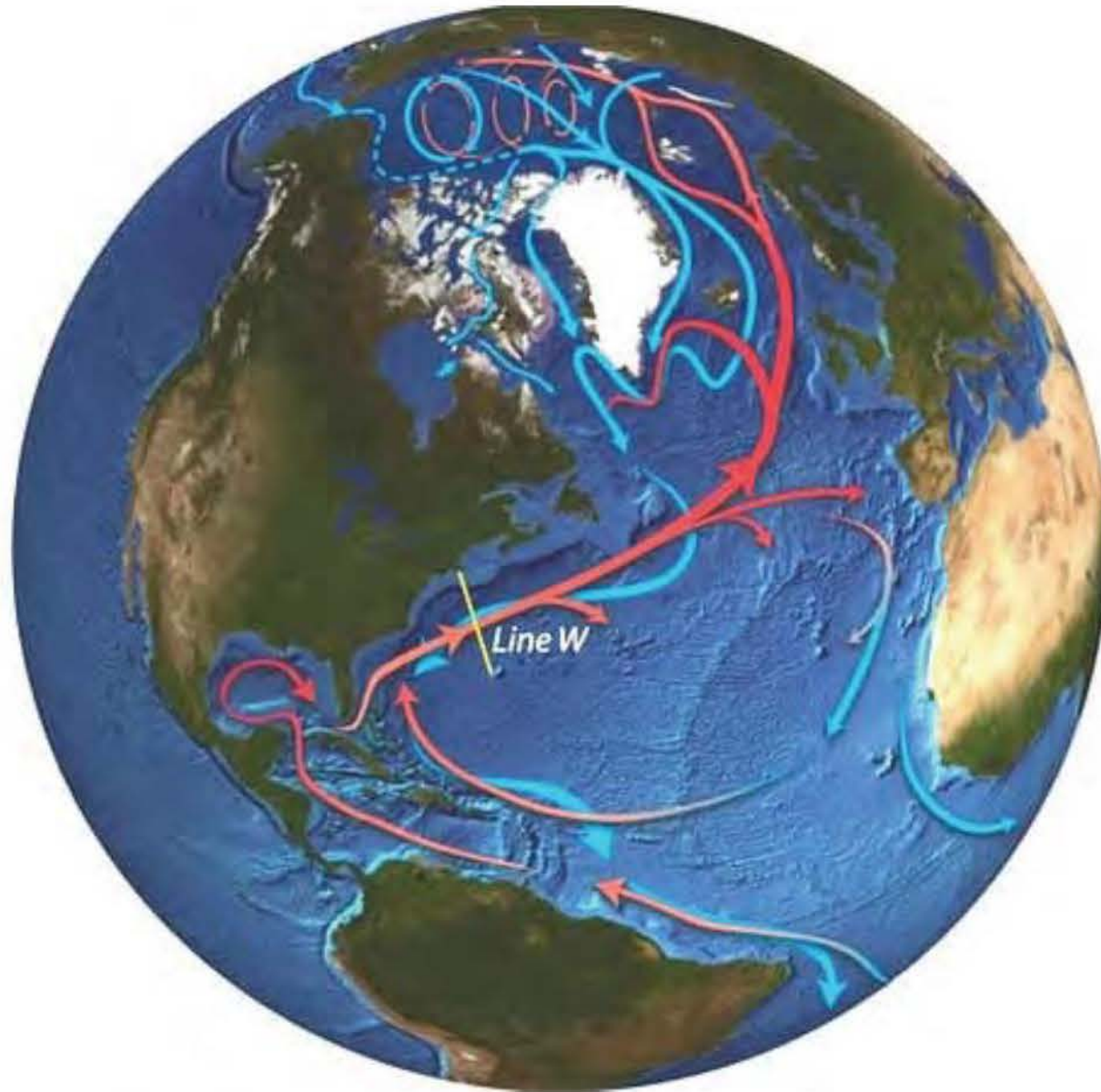

(Jack Cook, WHOI Graphics Services)

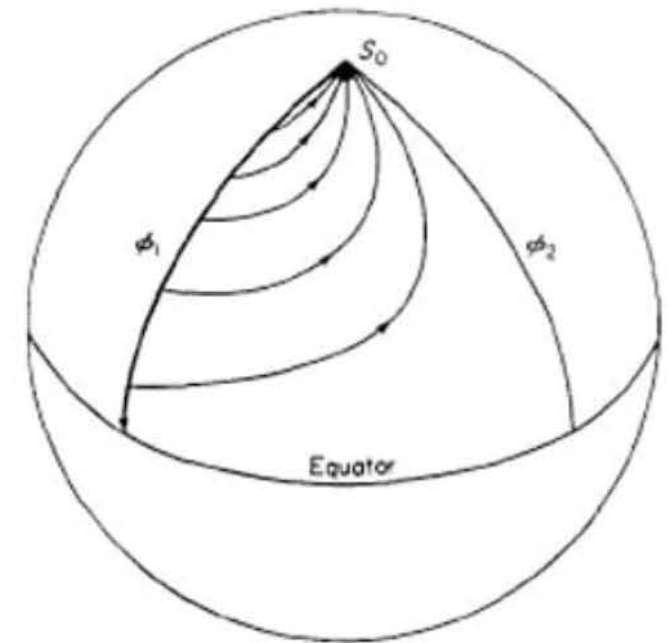
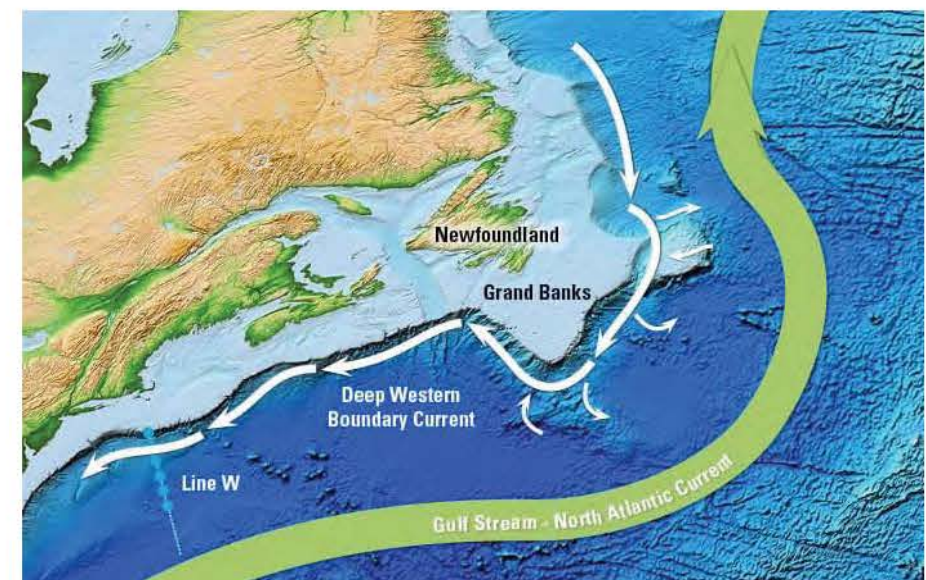

Fig. 6. Circulation pattern in meridionally bounded ocean with concentrated source  $S_0$  at North Pole and a uniformly distributed sink  $Q_0$ , such that  $S_0 = Q_0 a^2 (\phi_2 - \phi_1)$ .

Stommel and Arons (1959a)



(Eric S. Taylor, WHOI Graphics Services. Base map from NOAA)



## 2. Wind-driven Gyre

### THE WESTWARD INTENSIFICATION OF WIND-DRIVEN OCEAN CURRENTS

Henry Stommel

(Contribution No. 408, Woods Hole Oceanographic Institution)

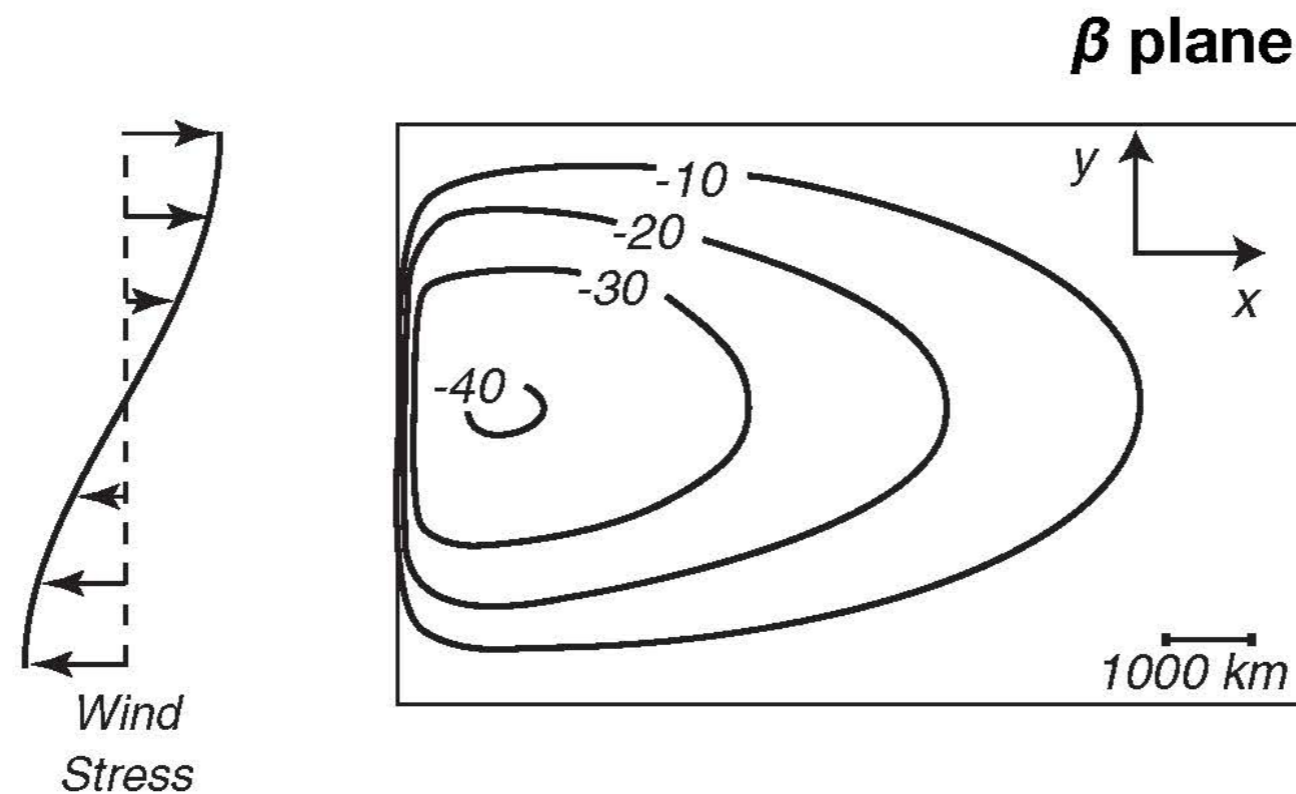

Stewart (2008) Fig 11.5 recreation of Stommel (1948) Fig. 4+5

[https://www.colorado.edu/oclab/sites/default/files/attached-files/stewart\\_textbook.pdf](https://www.colorado.edu/oclab/sites/default/files/attached-files/stewart_textbook.pdf)



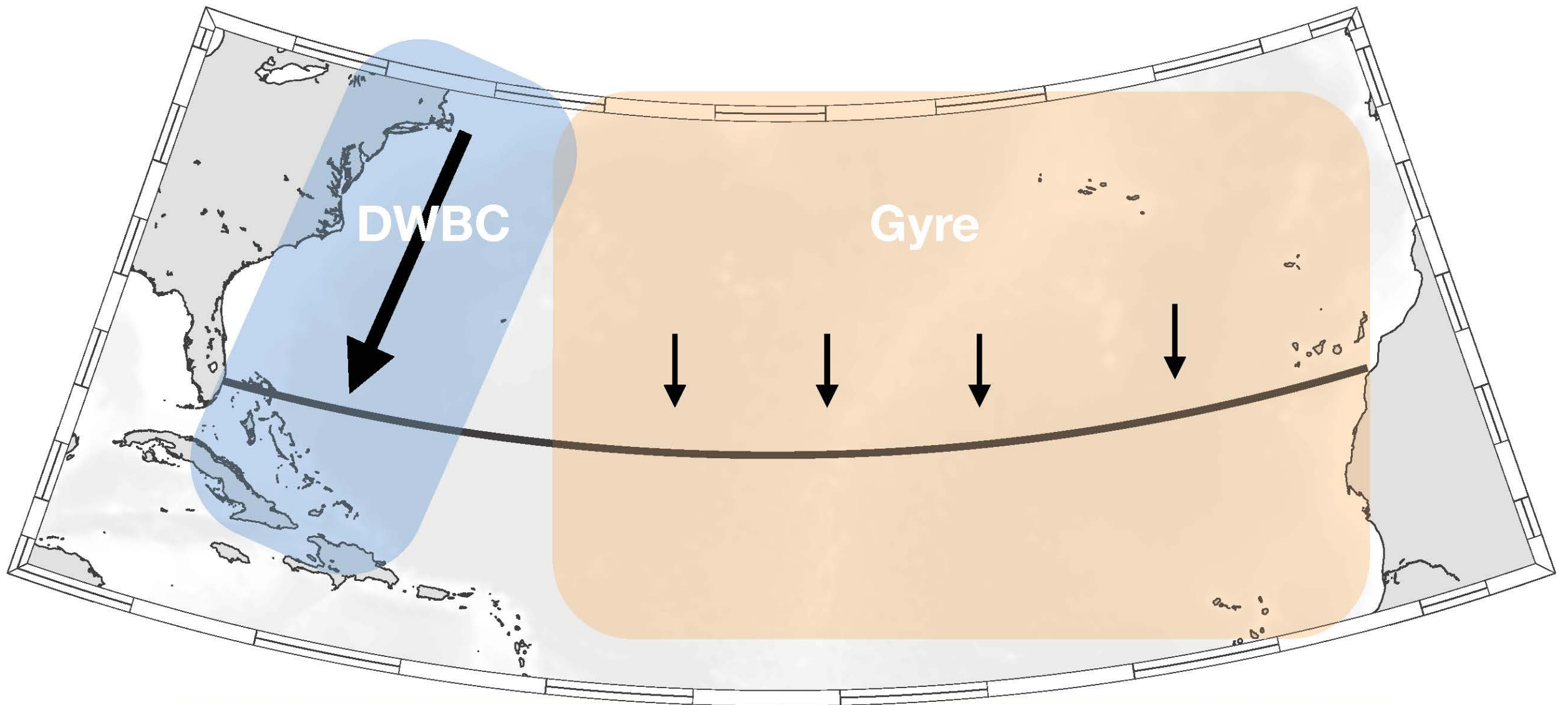

Deep Western Boundary Current	Sub-tropical Gyre
Southward transport	Southward transport
Bouyancy-driven	Wind-driven
Narrow, fast current	Broad; slow speeds
Coastal-refined resolution	Coarse resolution

## Results part 2: Western boundary current

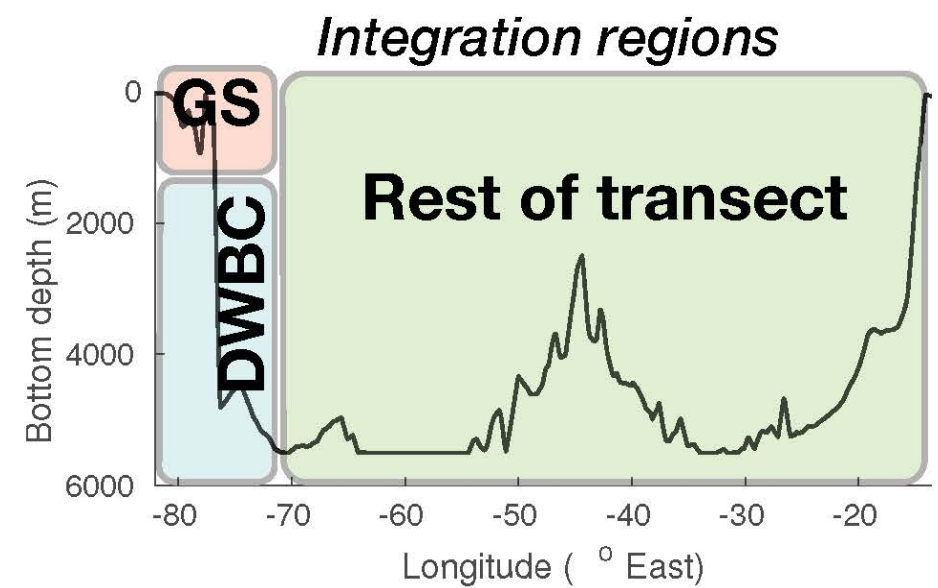
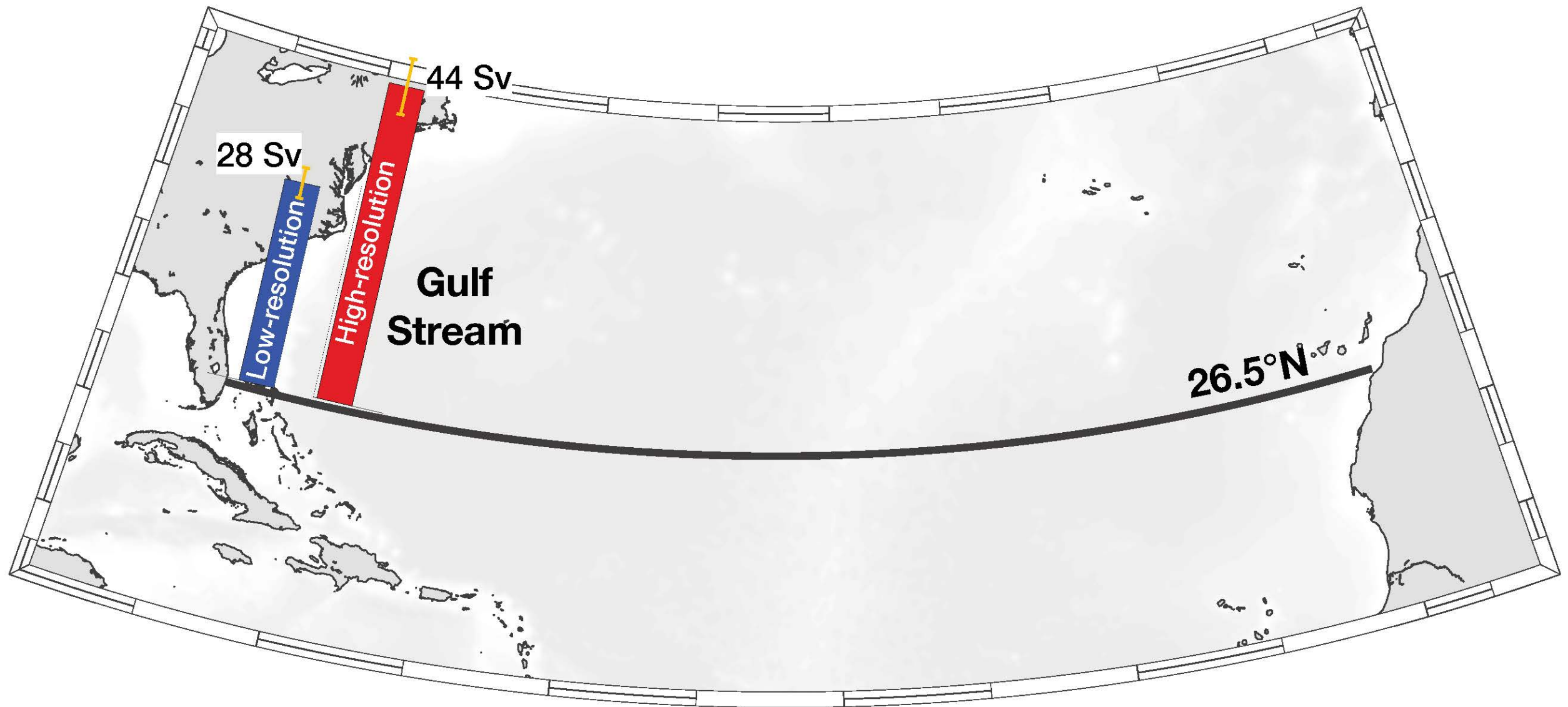

## Results part 2: Western boundary current

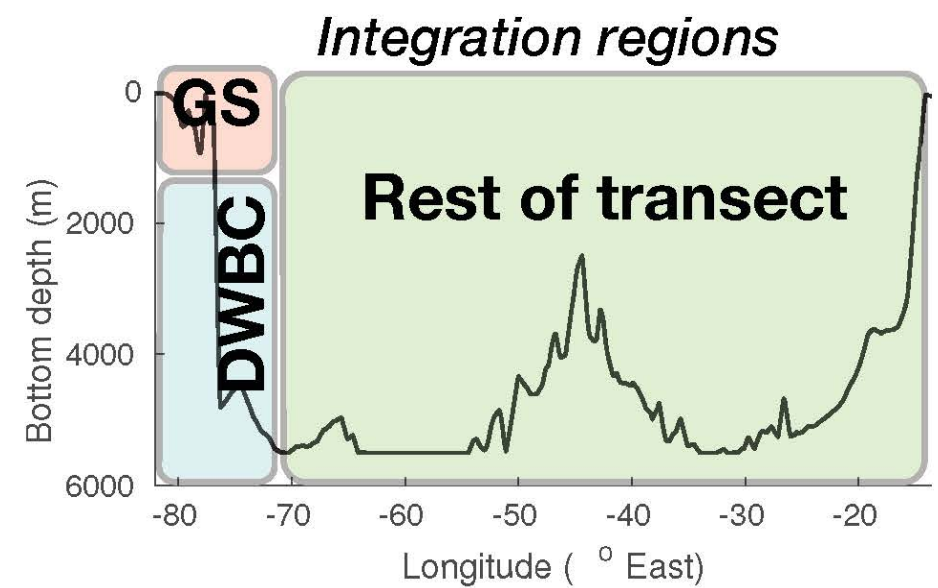
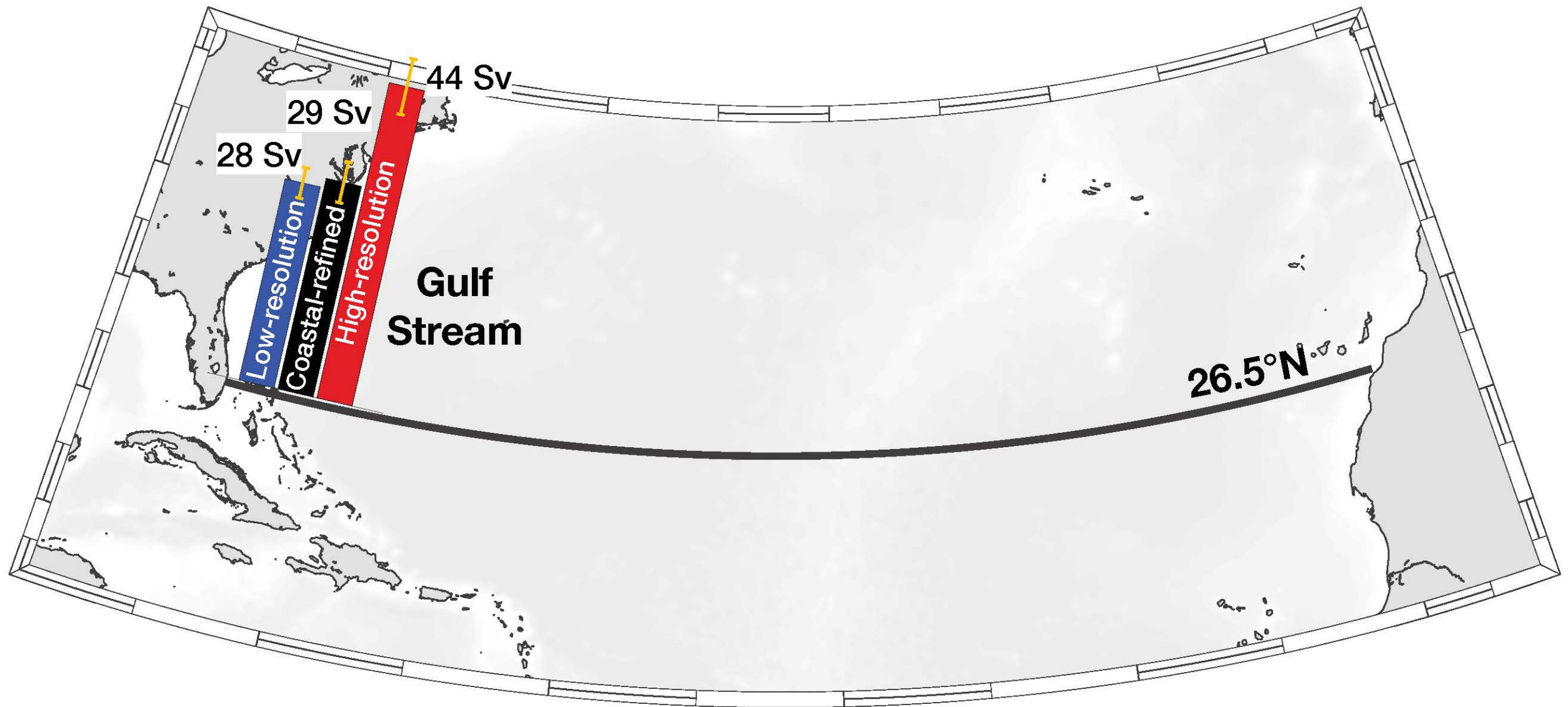



## Results part 2: Western boundary current

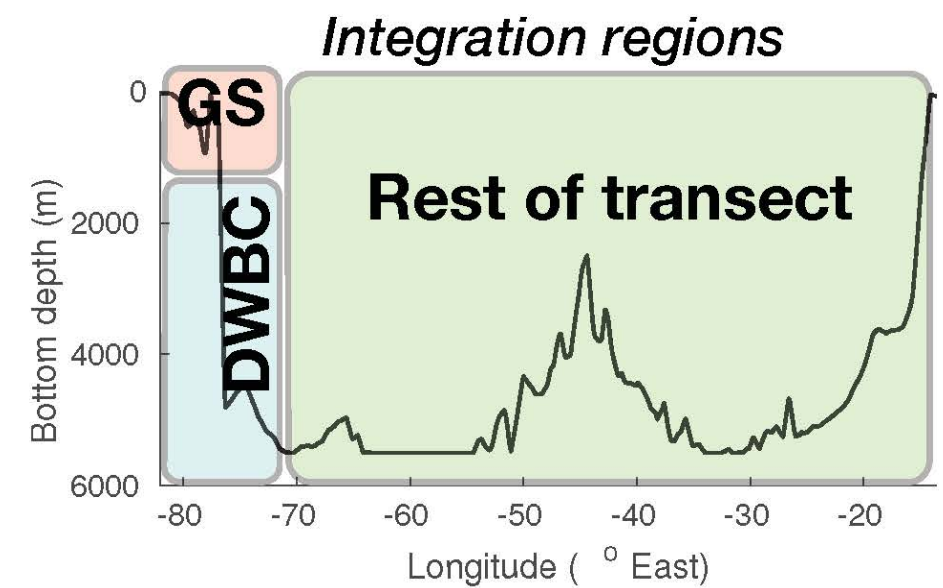
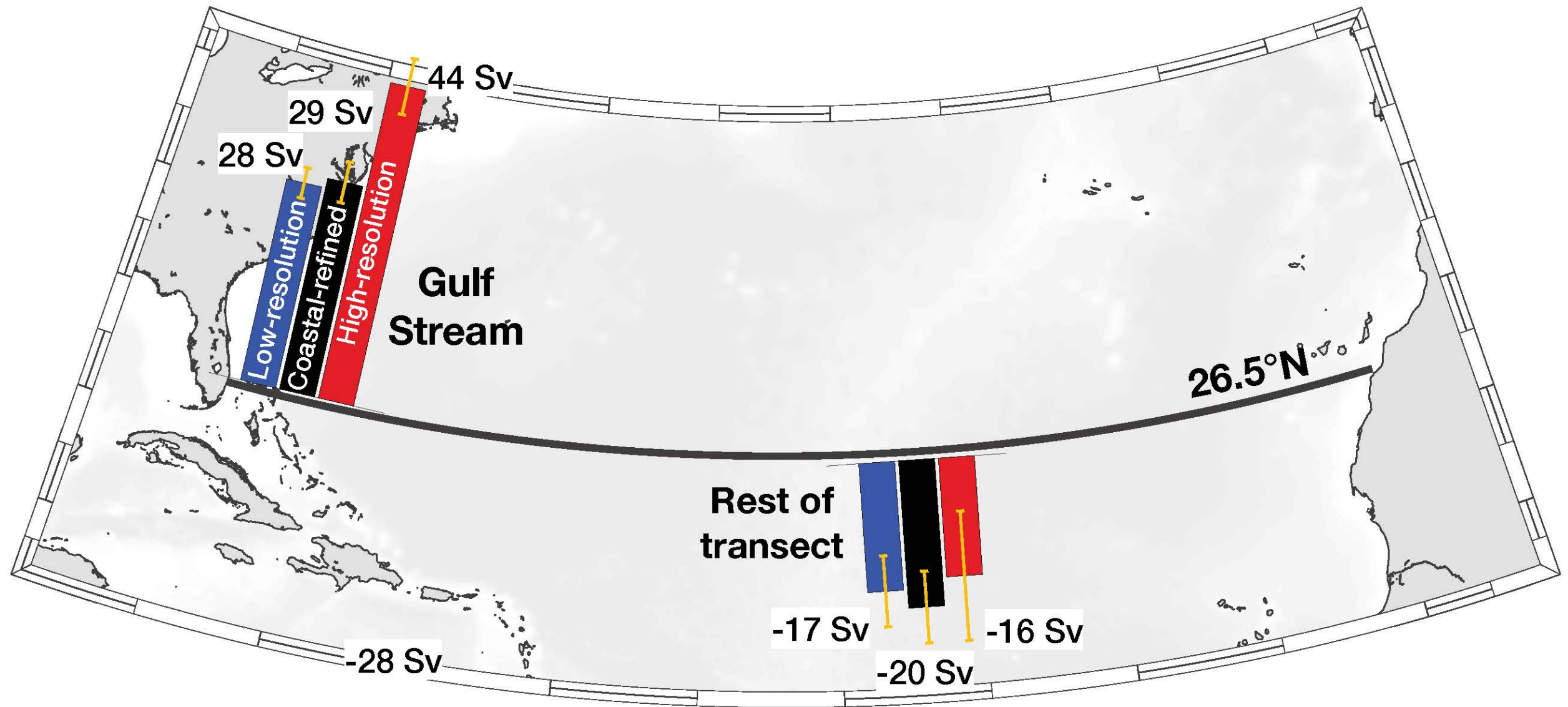

## Results part 2: Western boundary current

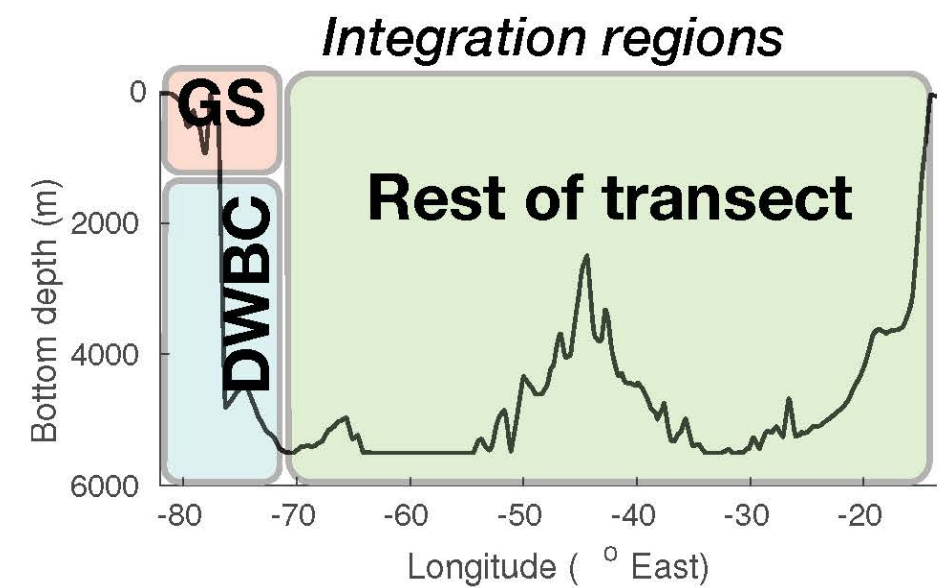
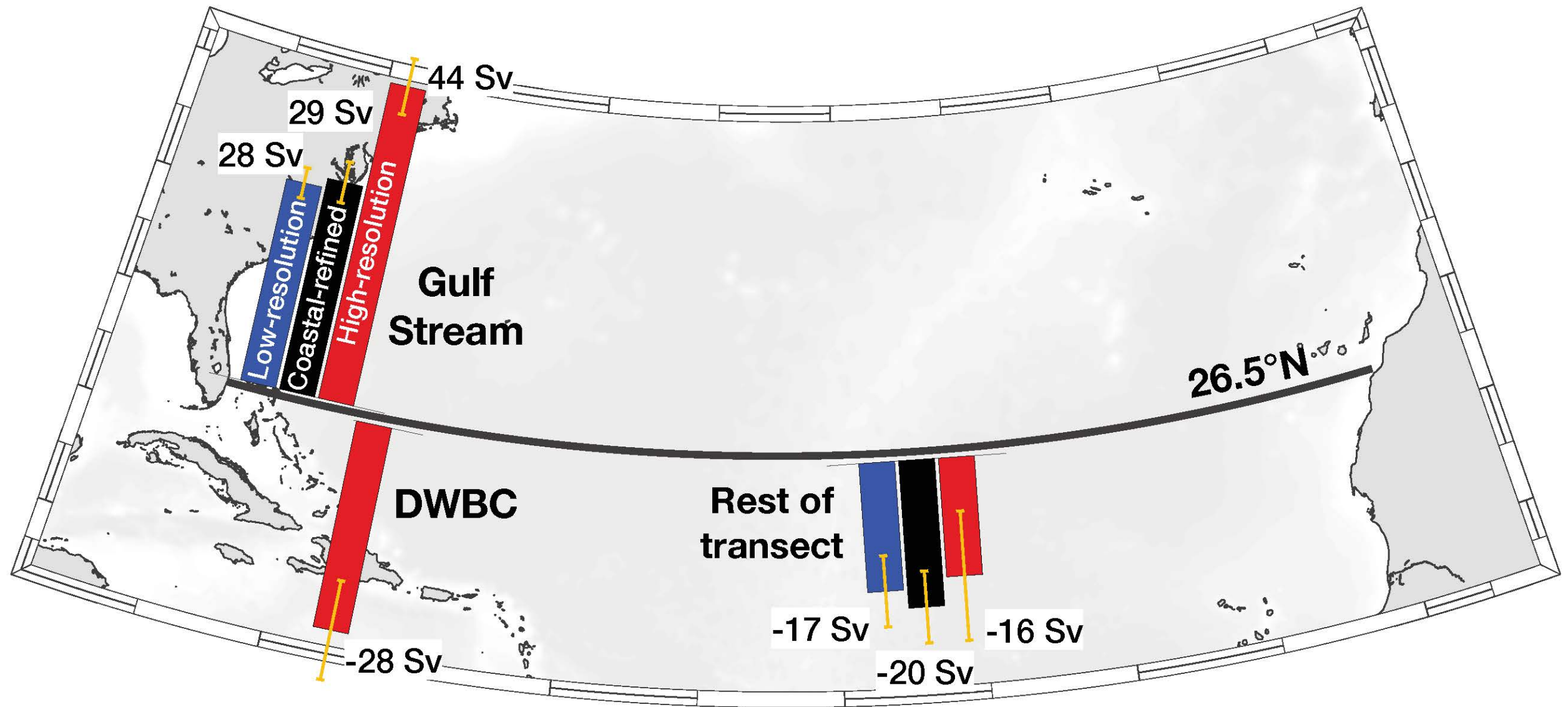

## Results part 2: Western boundary current

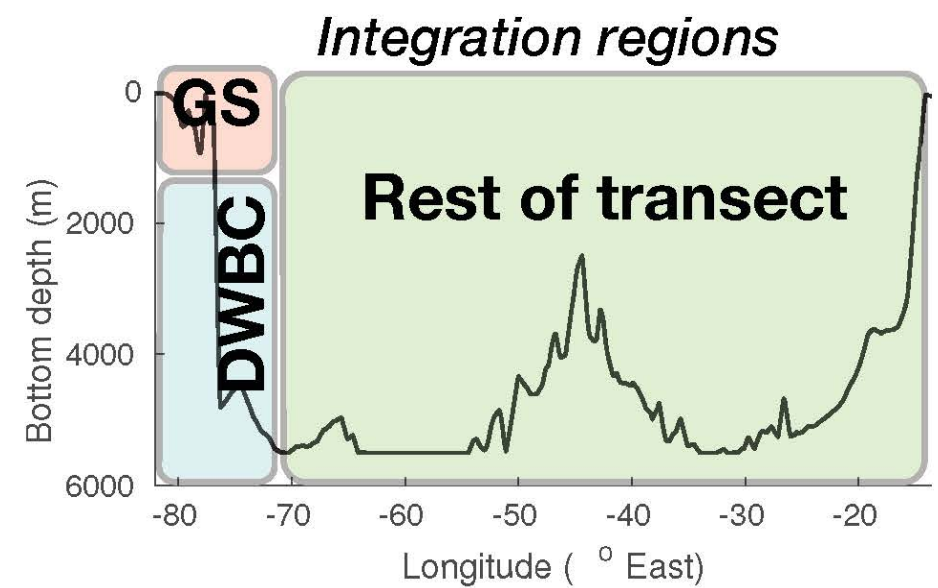
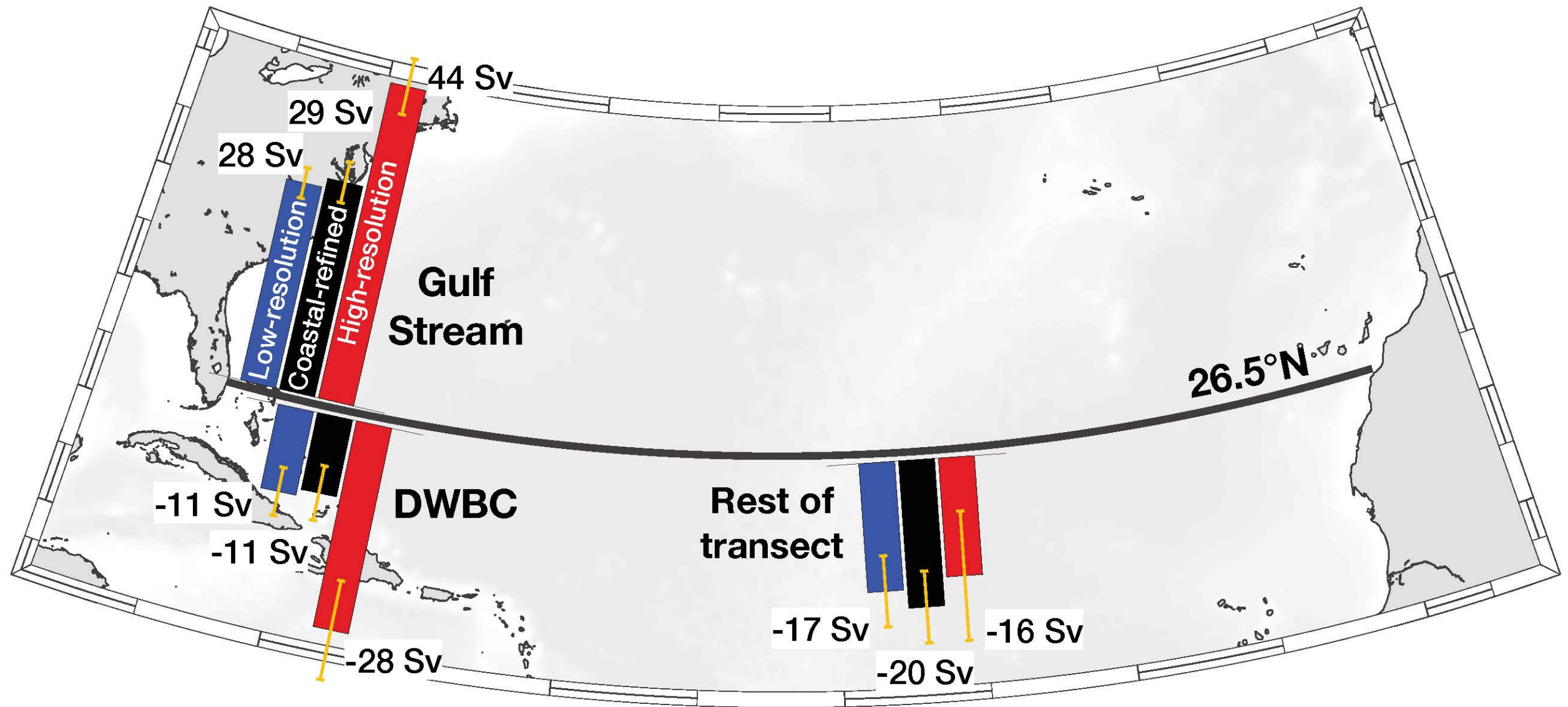



Low-resolution

### Mixed Layer Depth

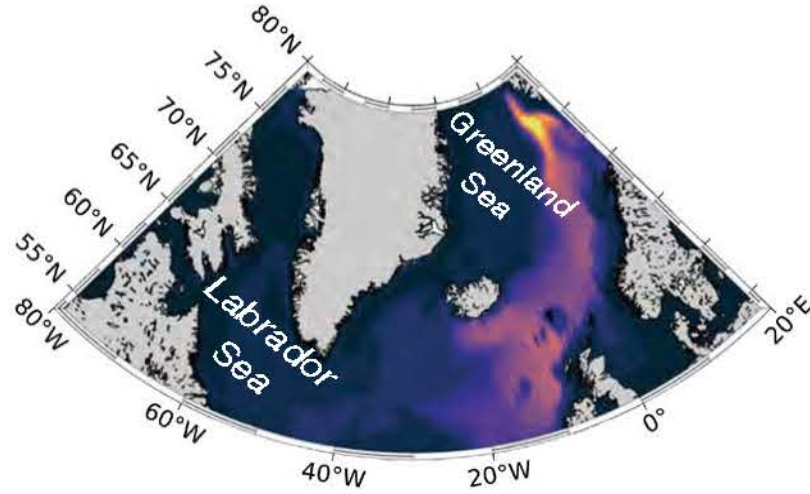

### Surface Salinity

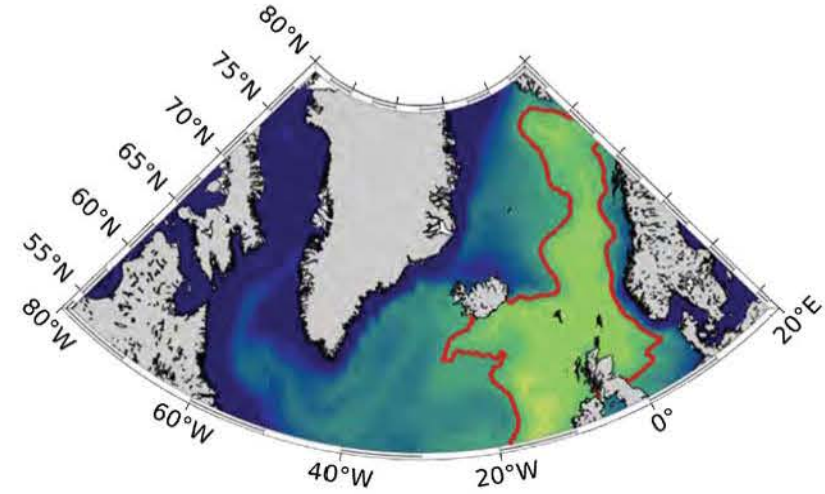

Coastal-refined

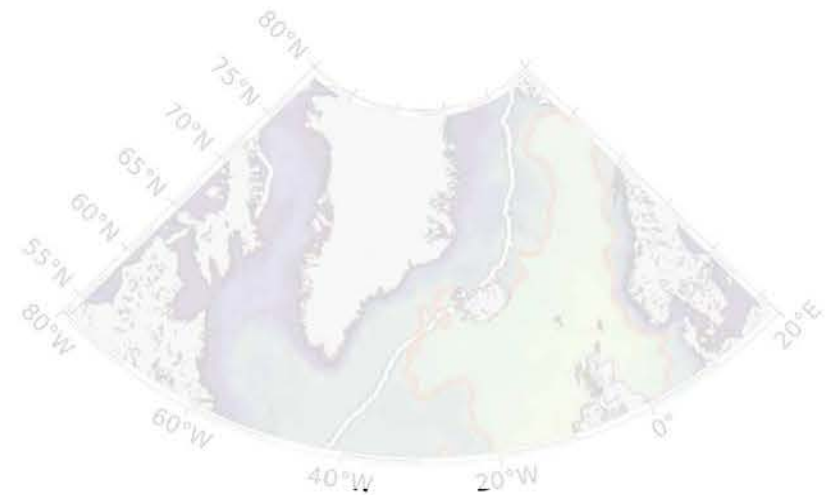

High-resolution

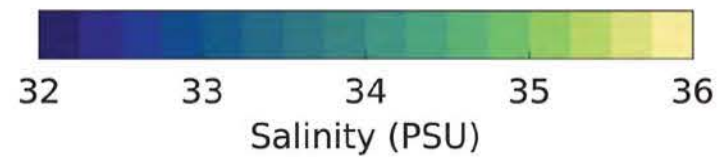
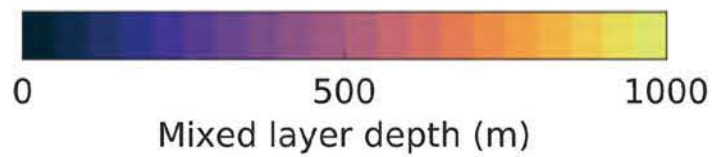
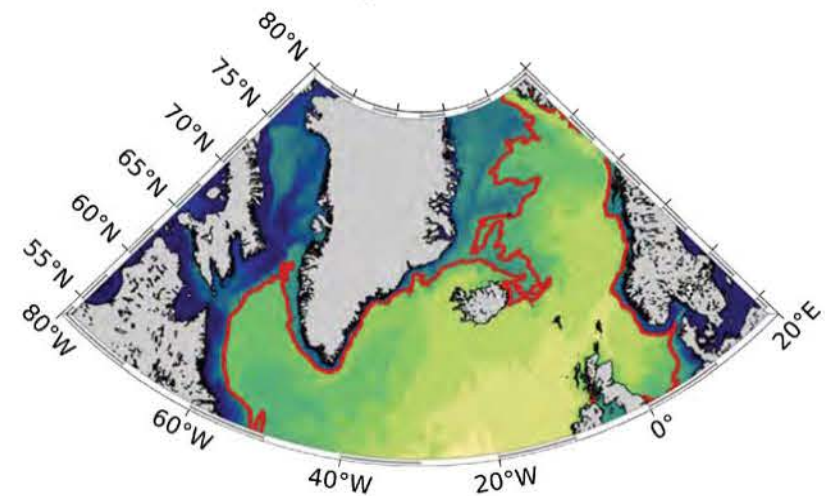
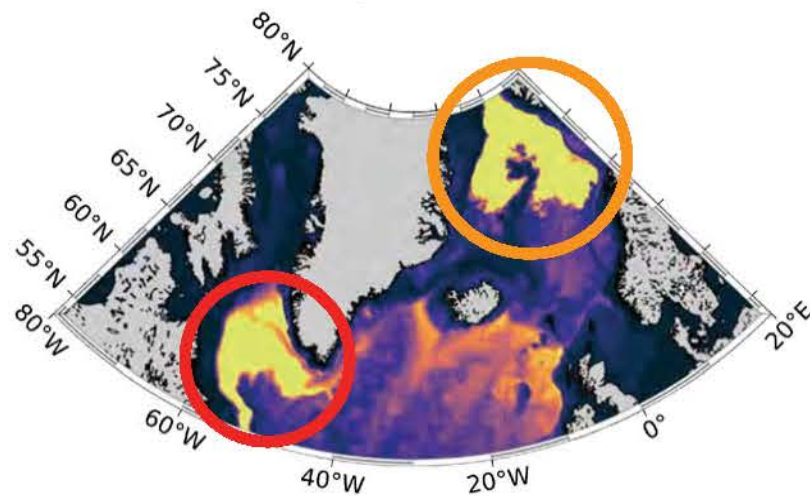



Low-resolution

Mixed Layer Depth

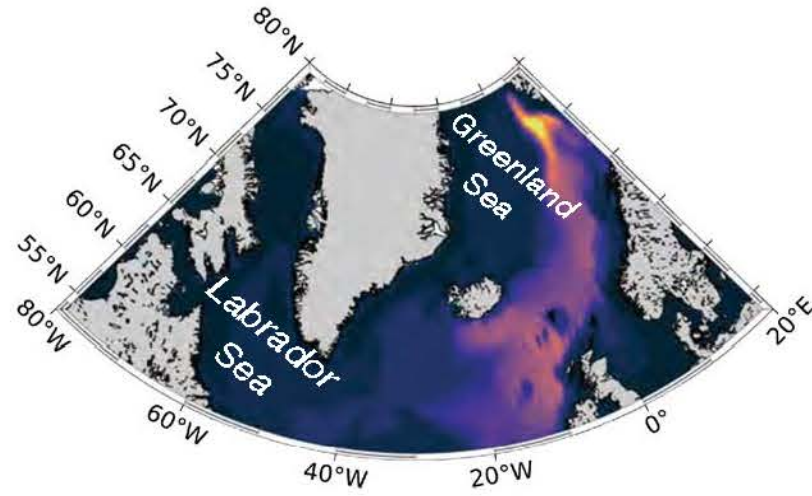

Surface Salinity

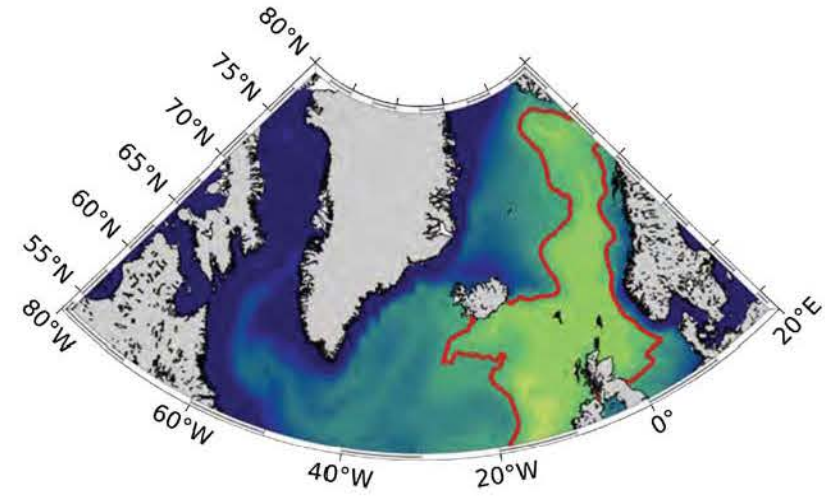

Coastal-refined

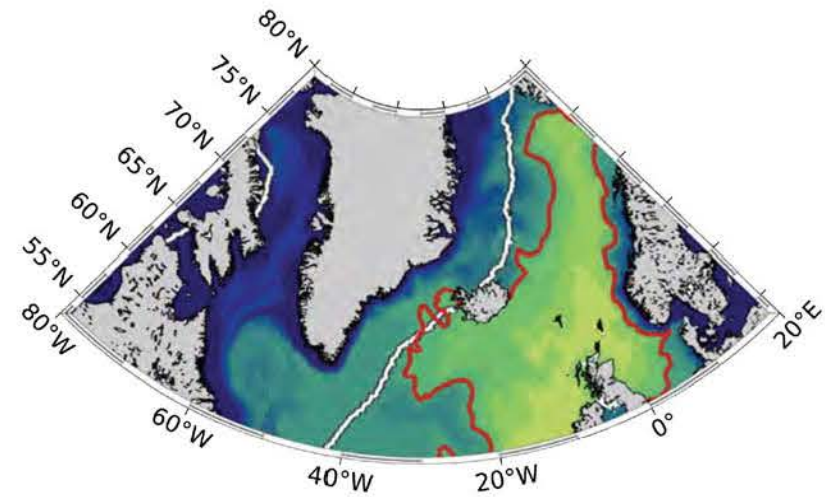
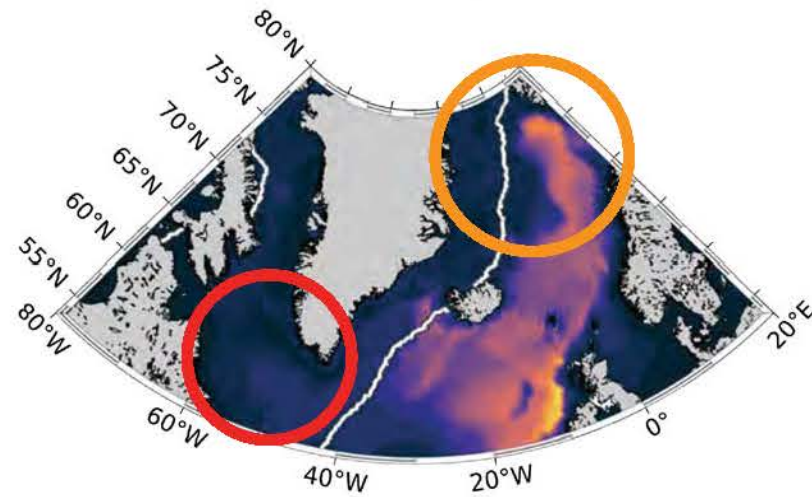

High-resolution

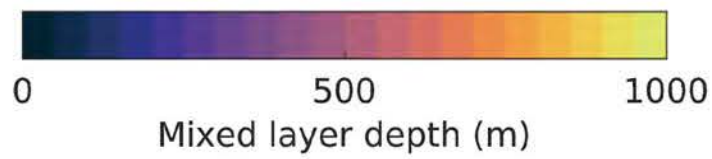
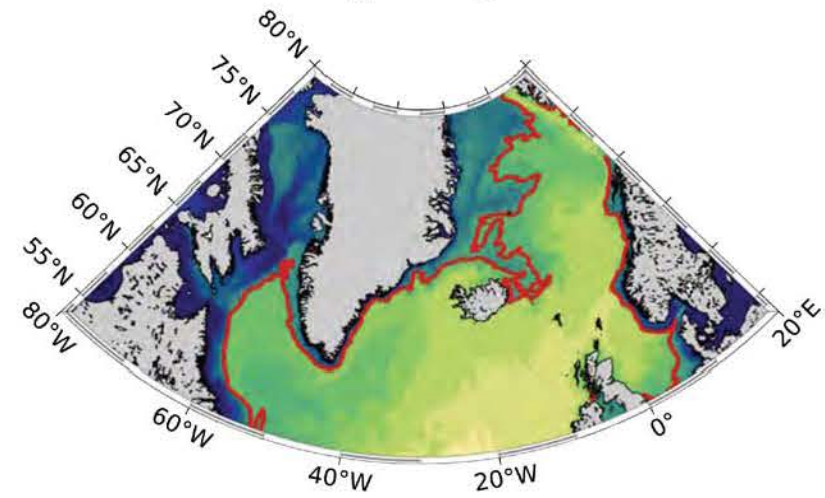
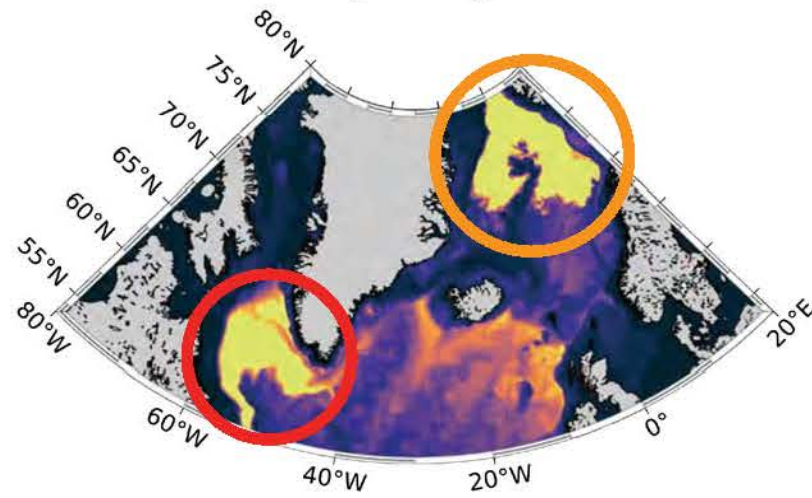

## Gulf Stream path influenced by resolution?

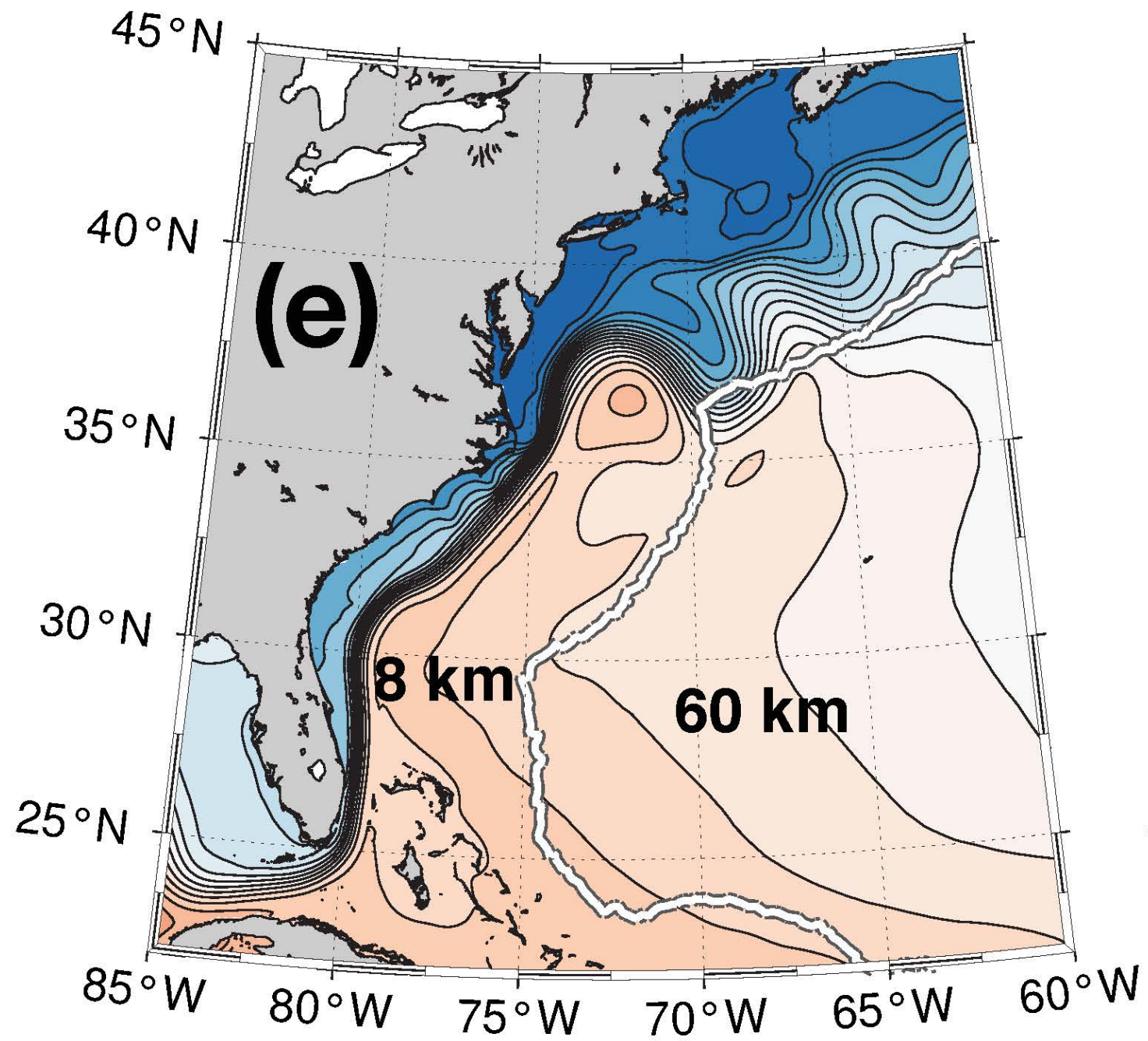



## Gulf Stream path influenced by resolution?

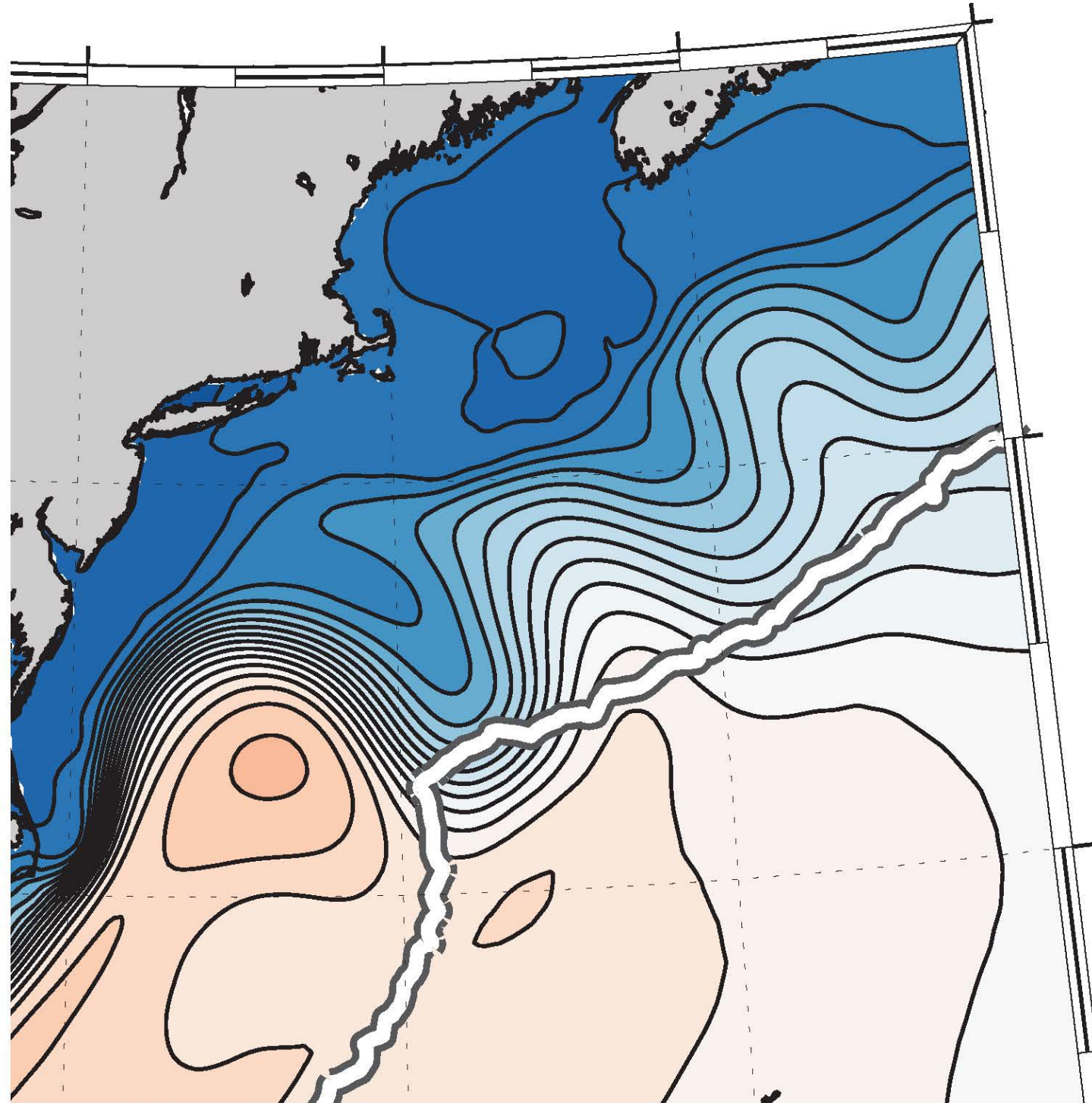



## Results part 2: Western boundary current

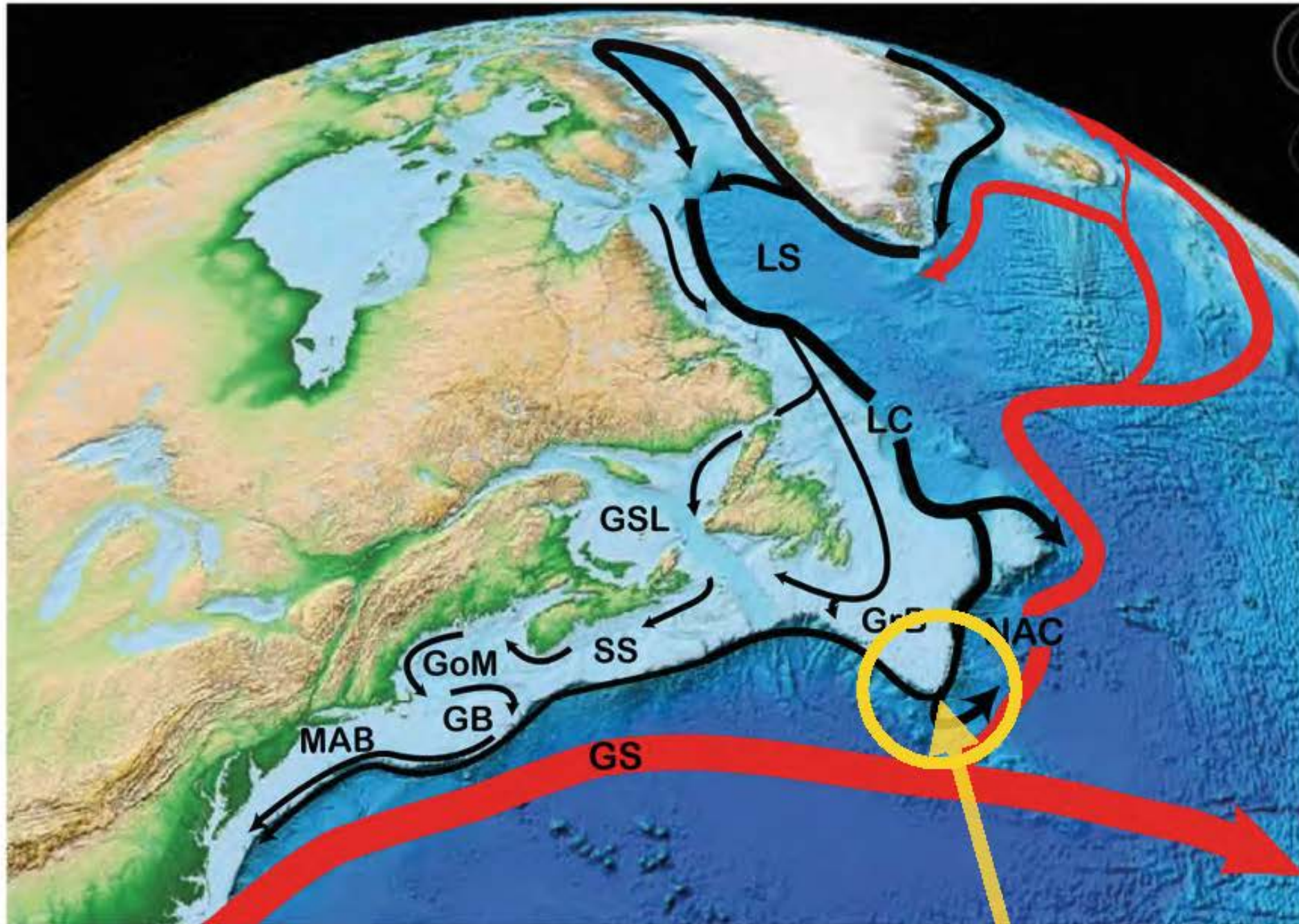

*MERCINA Working Group (2012)*

Tail of the Grand Banks:  
key "pinch point"



# GS / Labrador Current interactions: Salinity at 250 m

**GOOD**

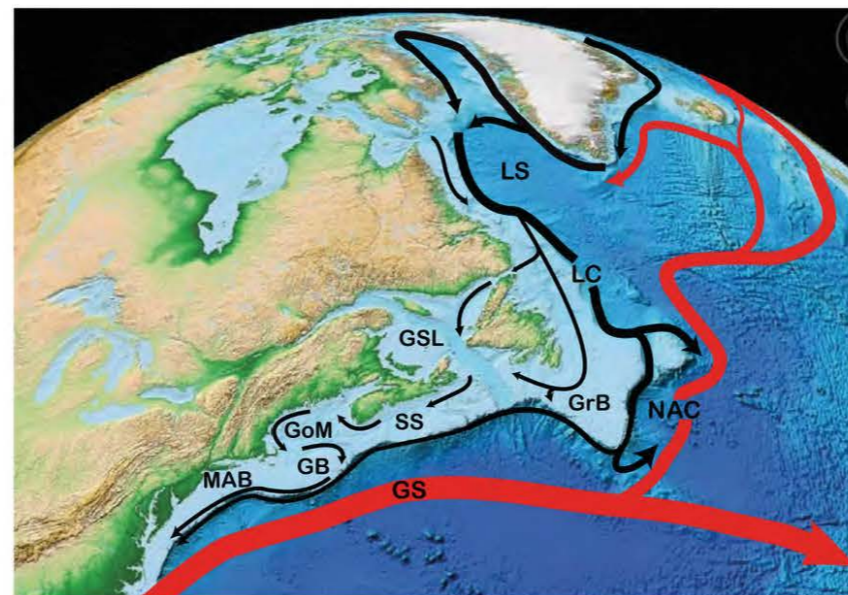
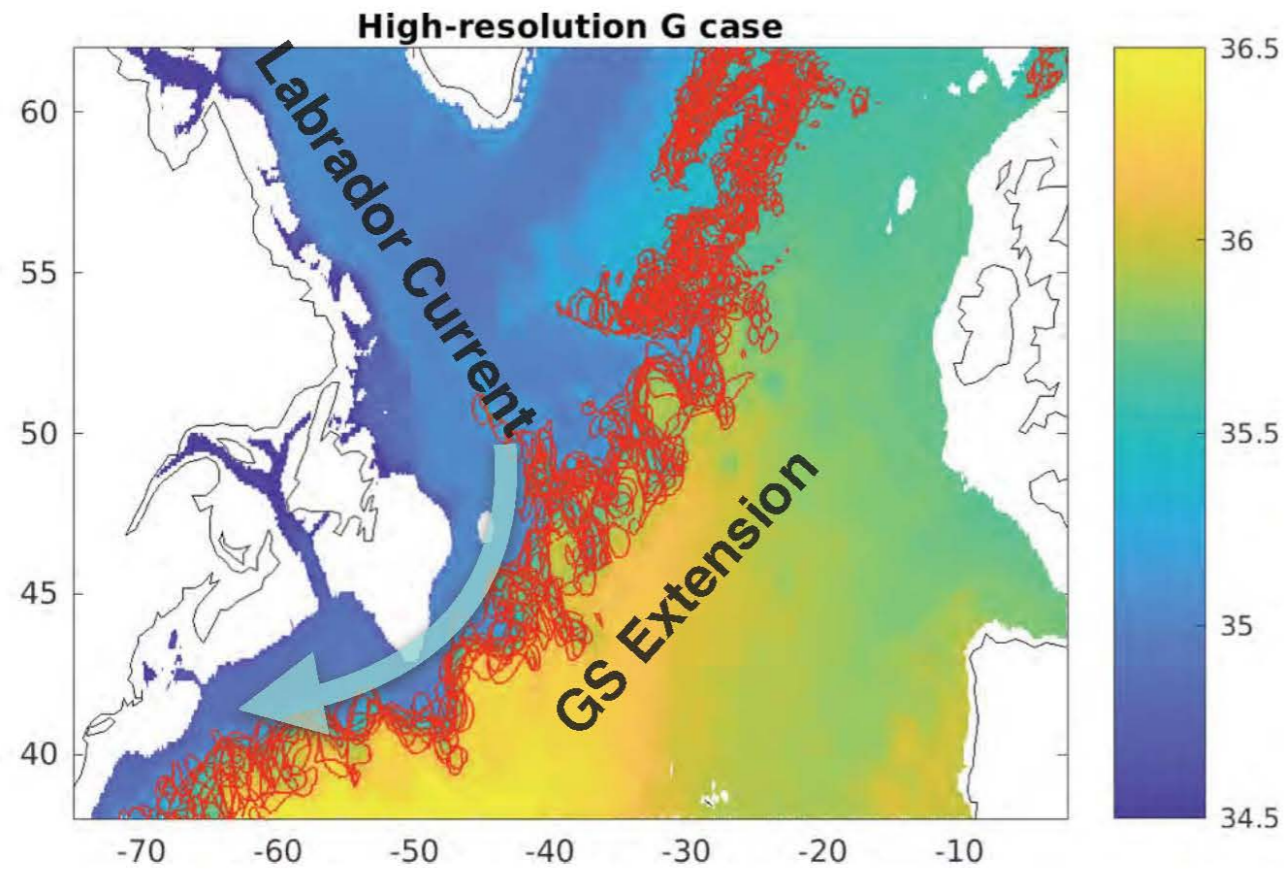



# GS / Labrador Current interactions: Salinity at 250 m

**GOOD**

High-resolution G case

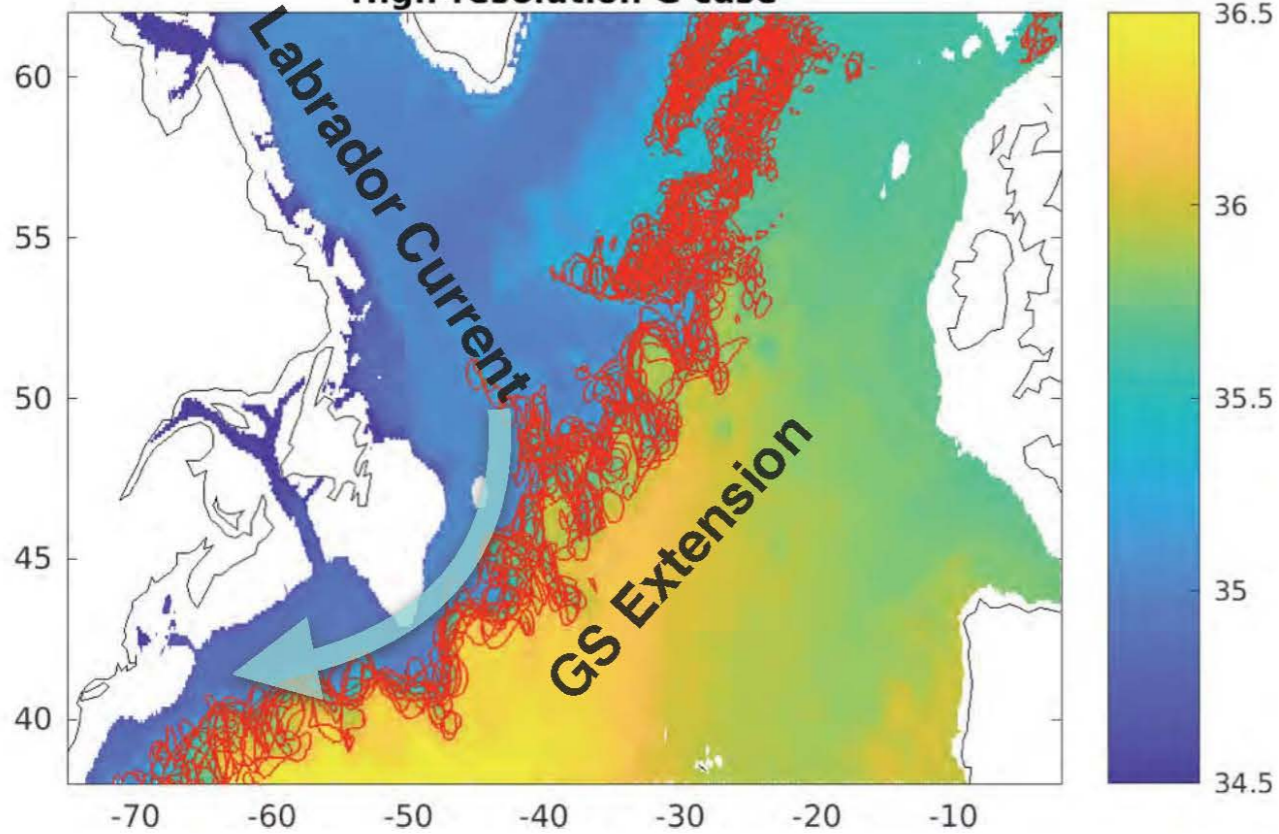

**BAD**

Coastally-refined G case

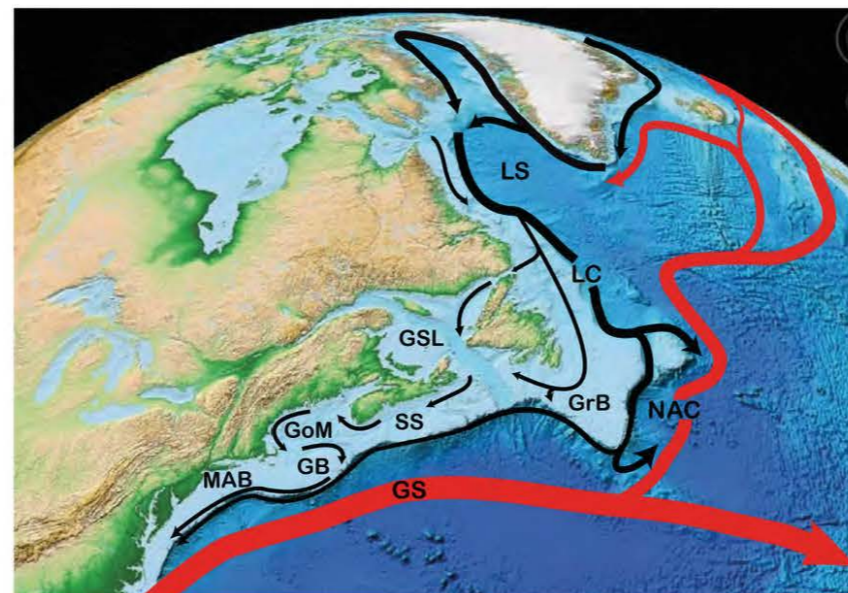
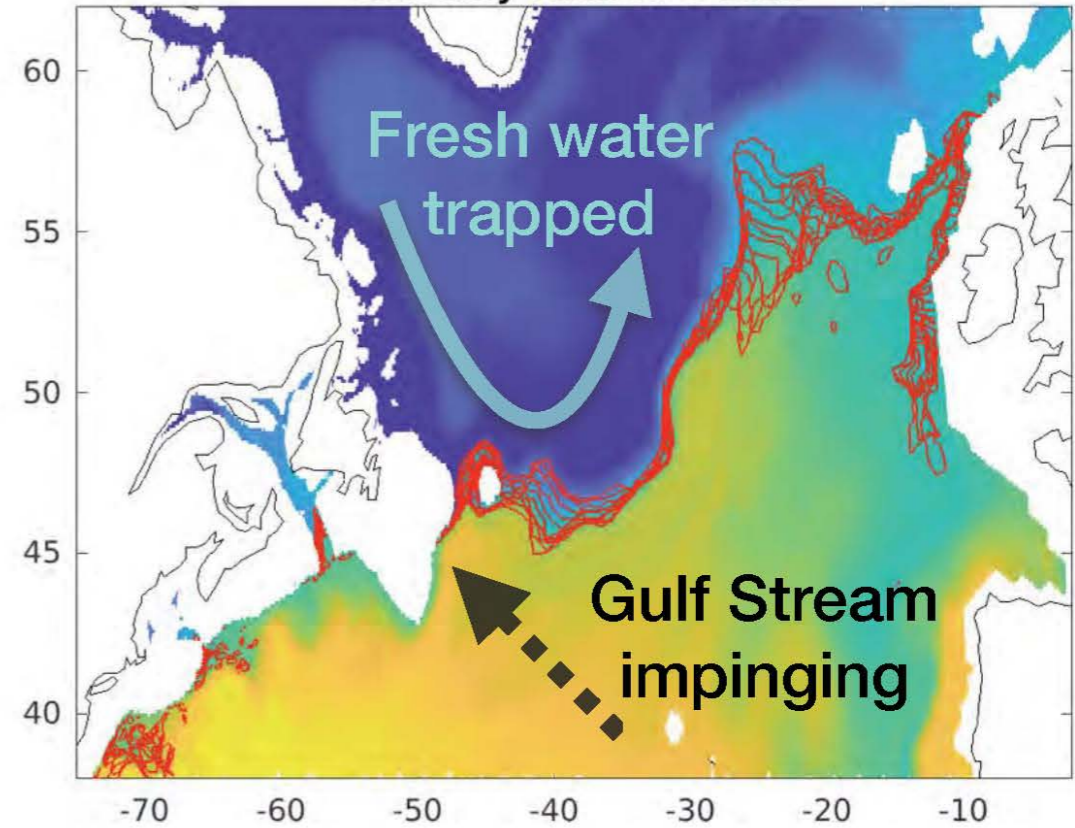



# REVIEW



Gulf Stream path being steered by mesh transition

GS impinging on Labrador Current

Weak Gulf Stream

Freshening of Lab Sea

Weak DWBC

Low deepwater formation

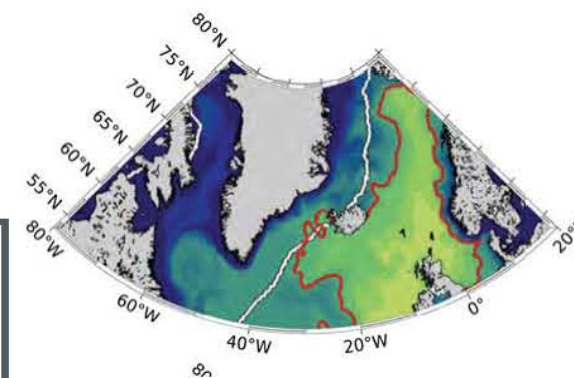
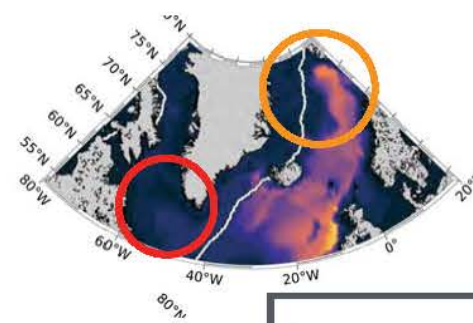
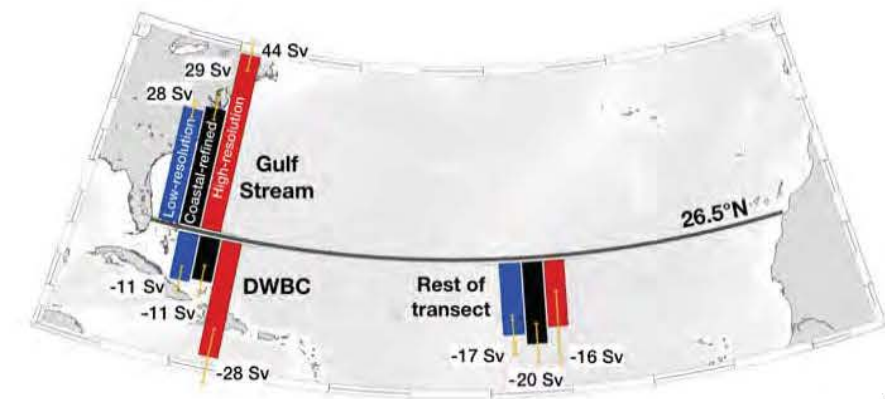
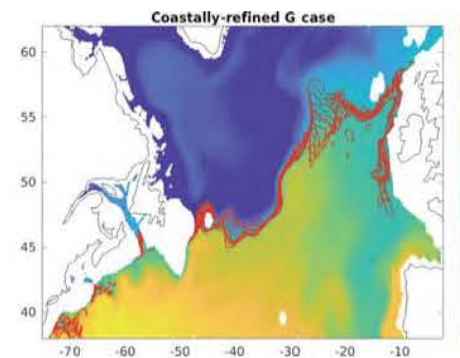
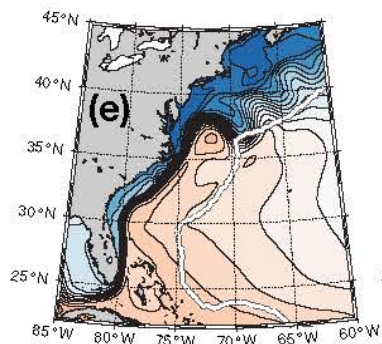



# Ongoing work

Old



New

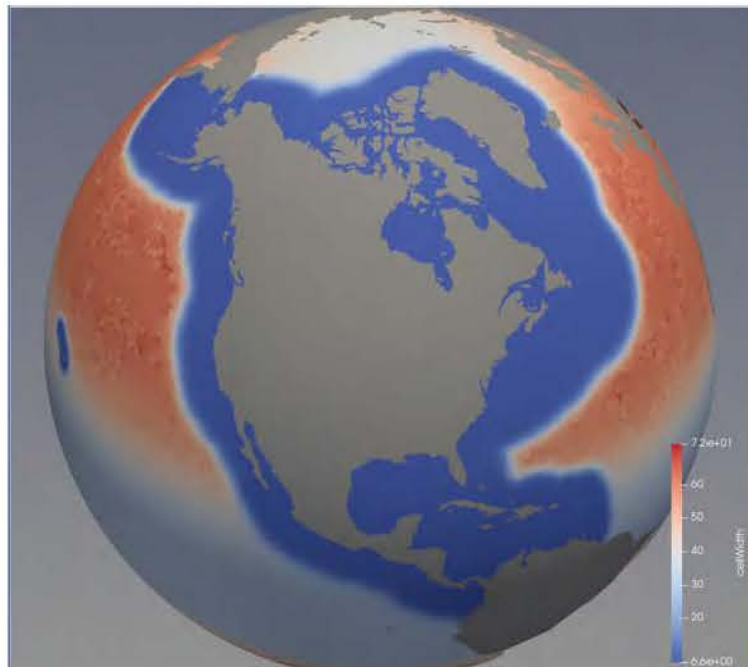

*Extending refinement around Gulf Stream Extension*

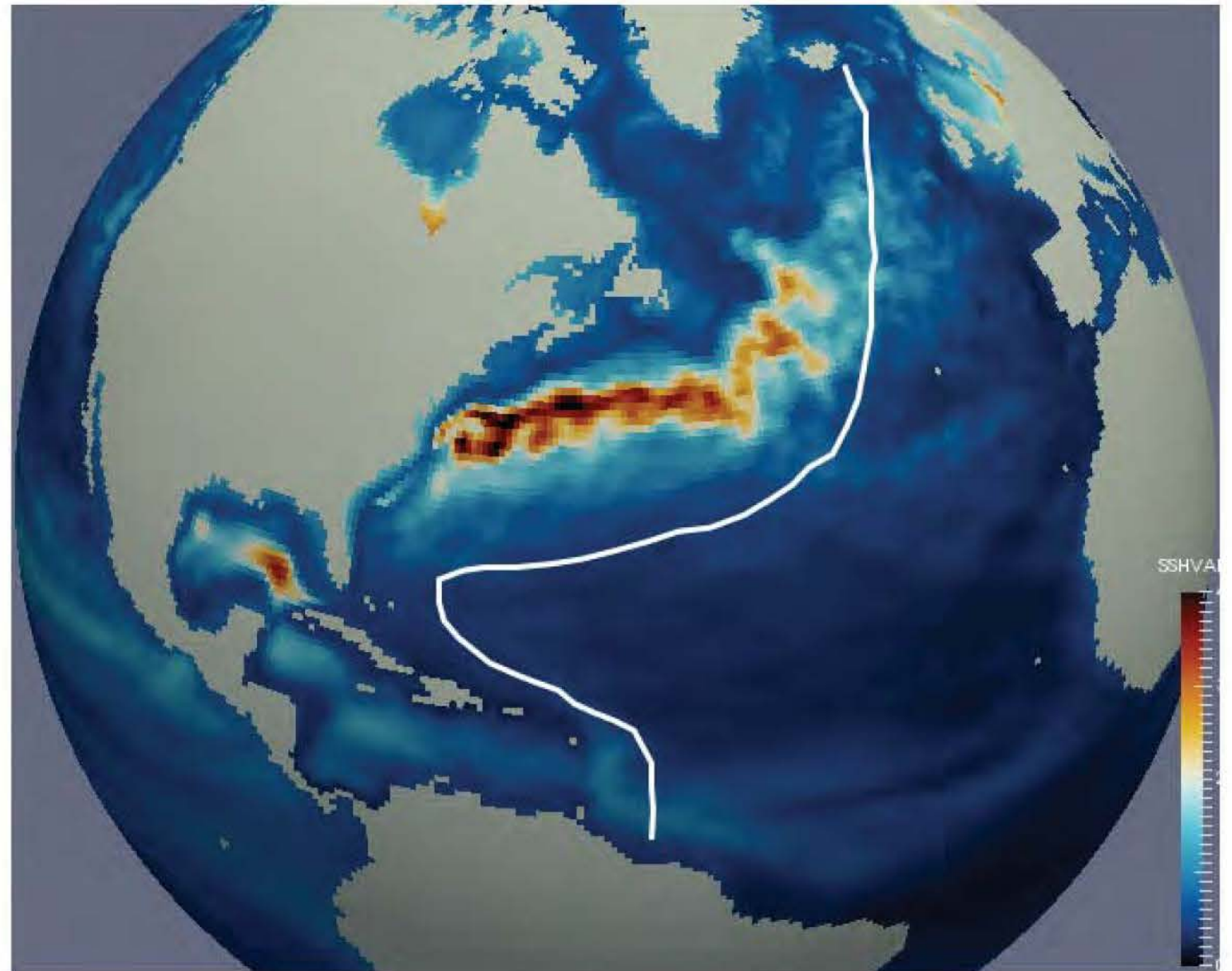

## Ongoing work

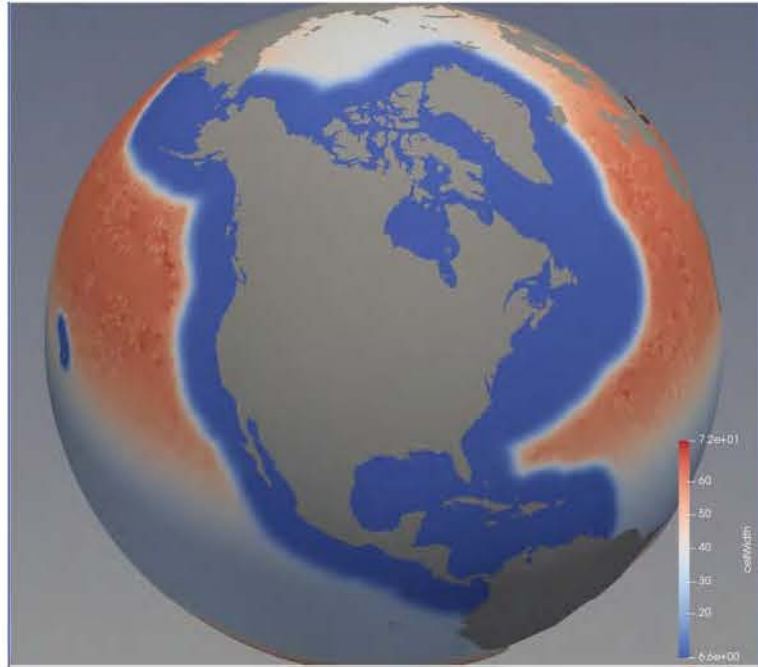

## Preliminary results: Improved path of Gulf Stream Extension

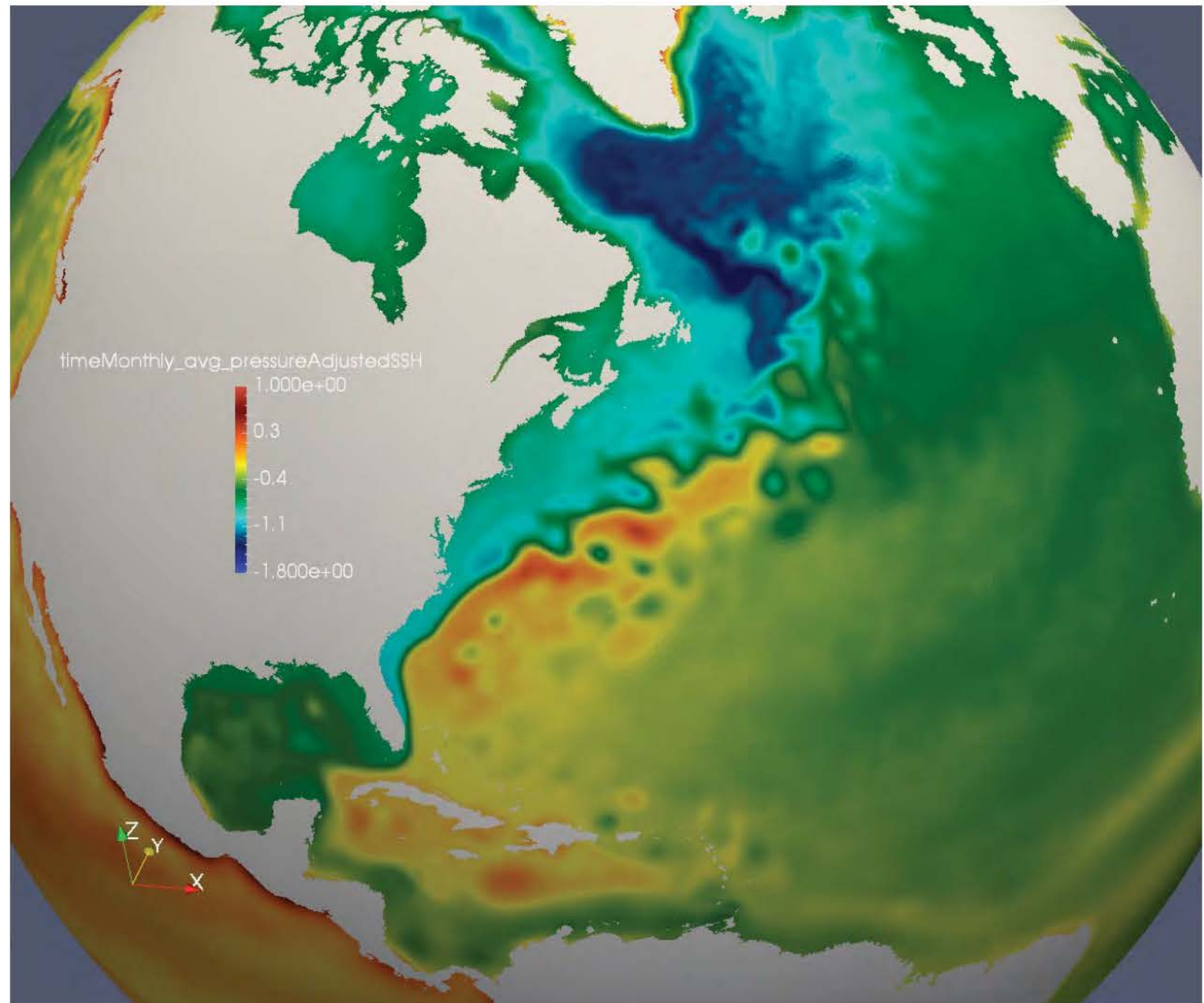



## Ongoing work

*Why* is the Gulf Stream path being affected by the mesh resolution transition?

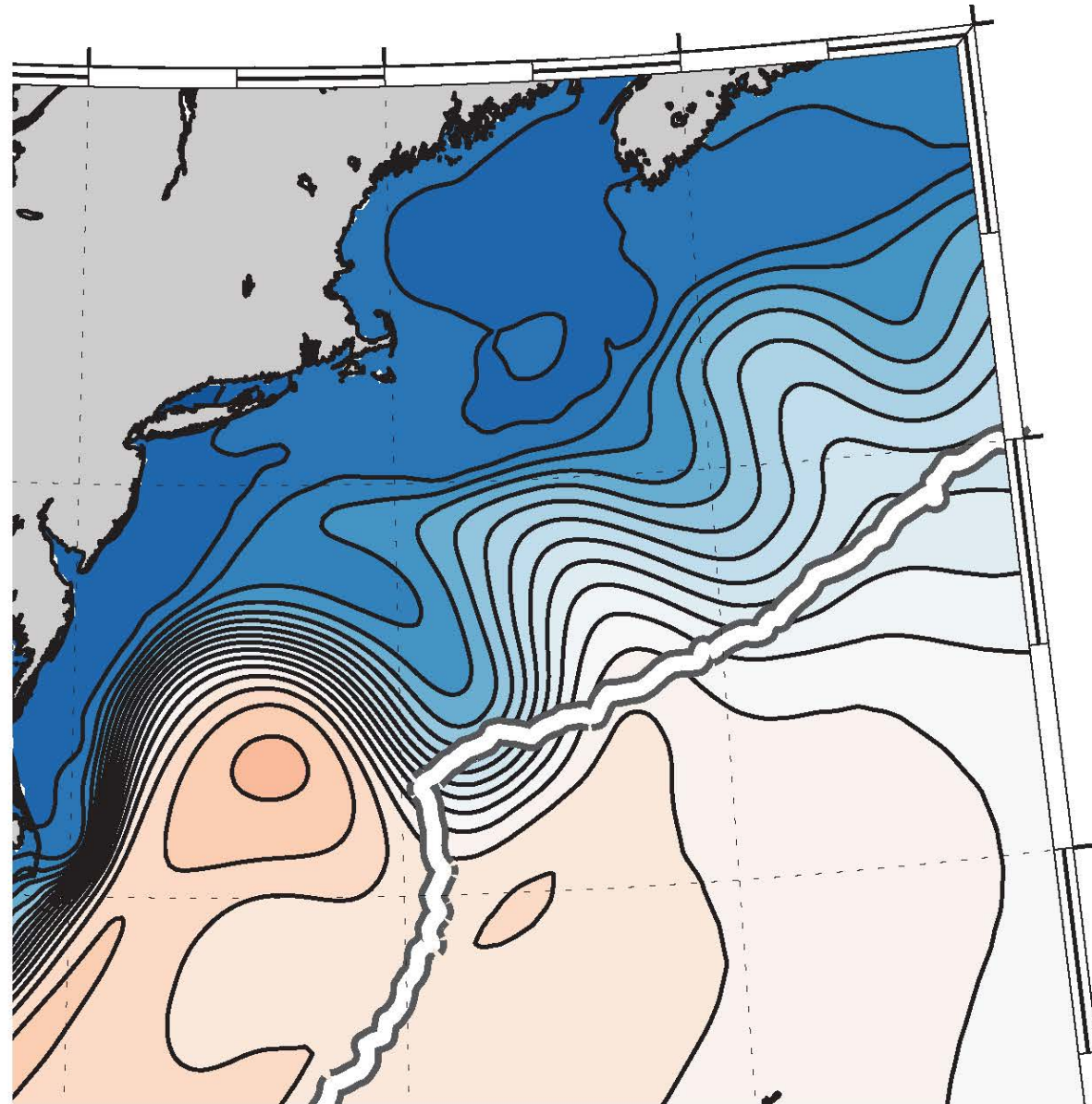



8 km resolution.  
Low viscosity



60 km resolution.  
High viscosity

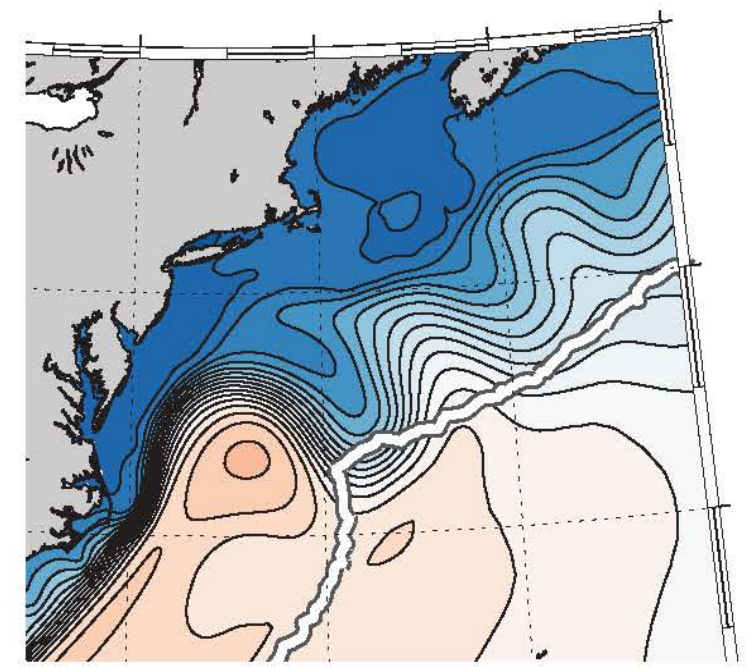
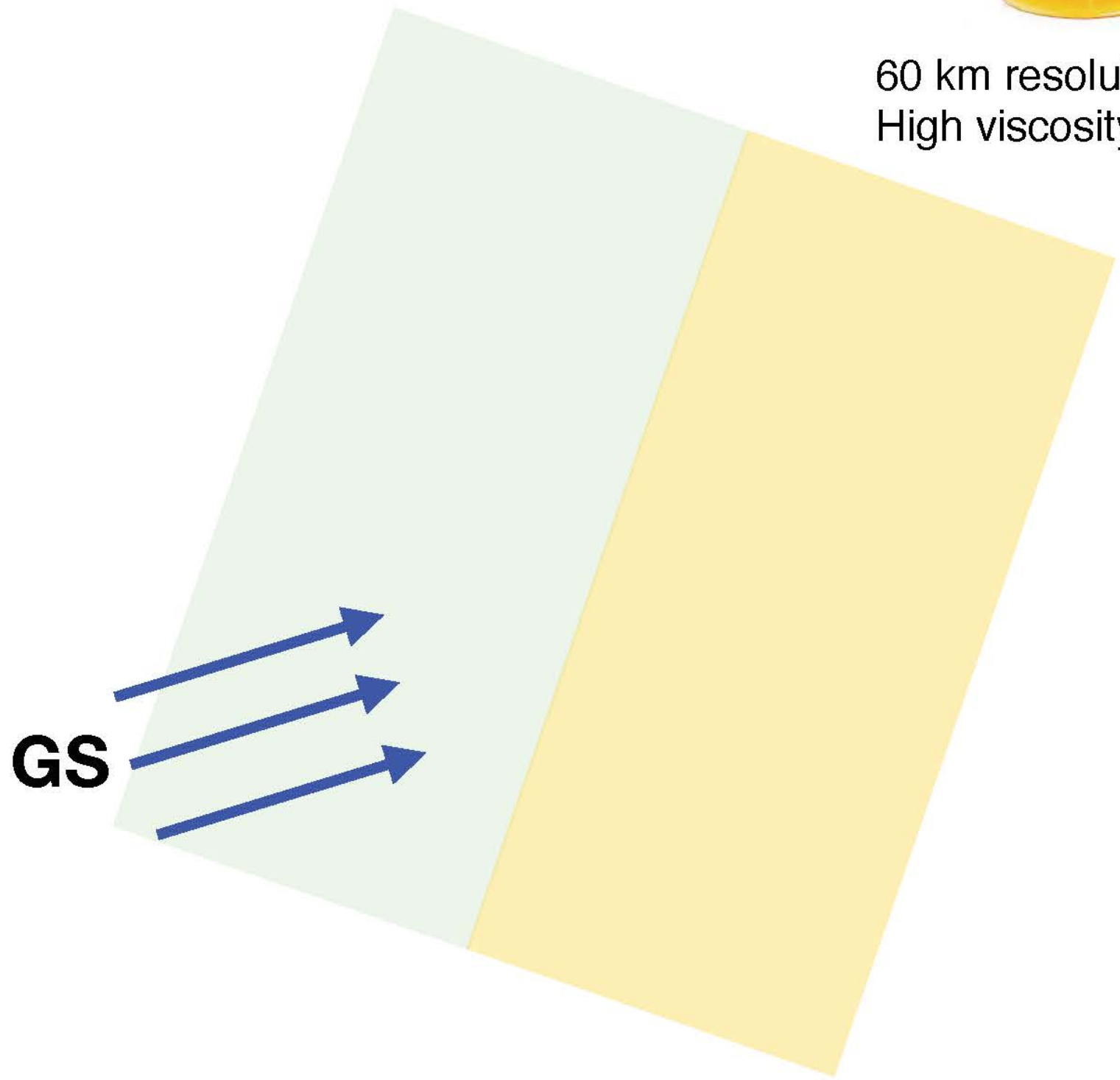





8 km resolution.  
Low viscosity



60 km resolution.  
High viscosity

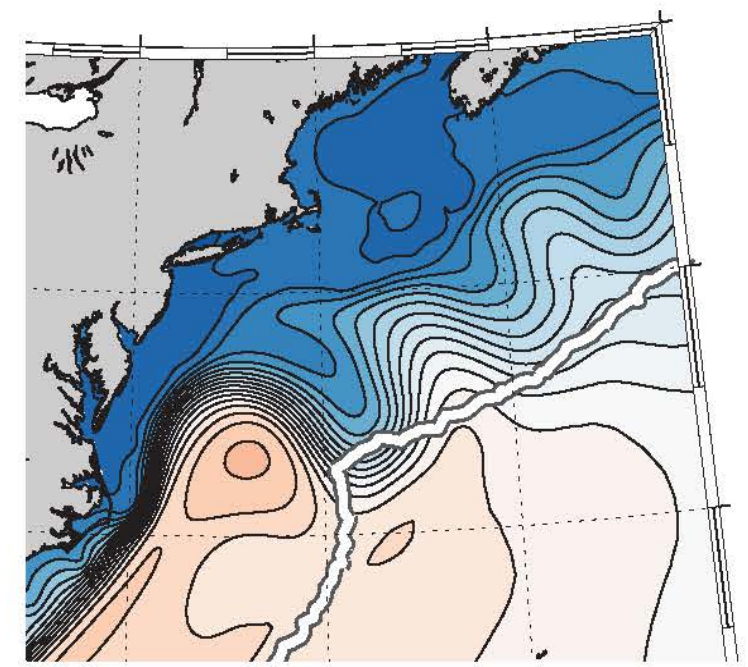
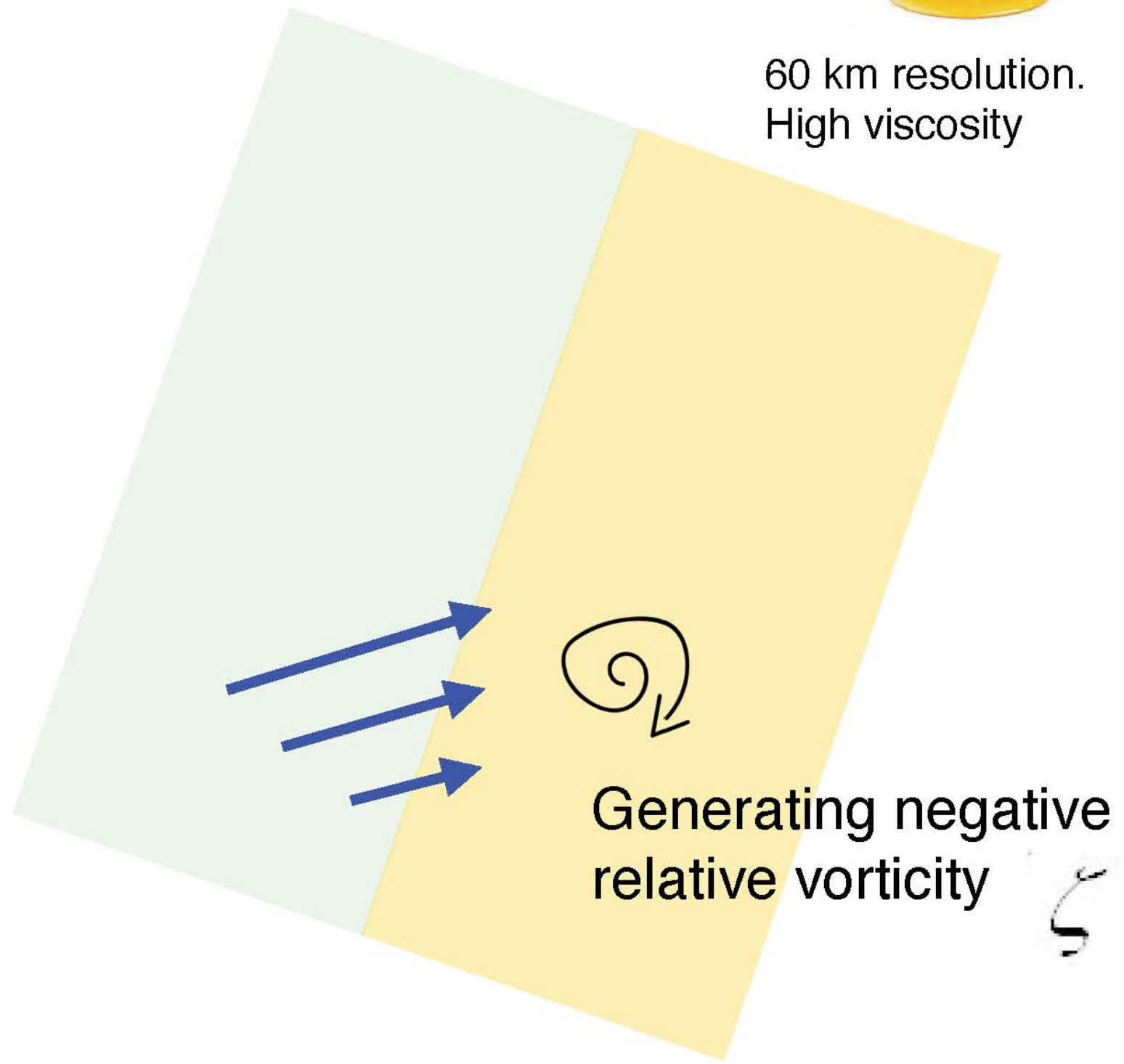



8 km resolution.  
Low viscosity



60 km resolution.  
High viscosity

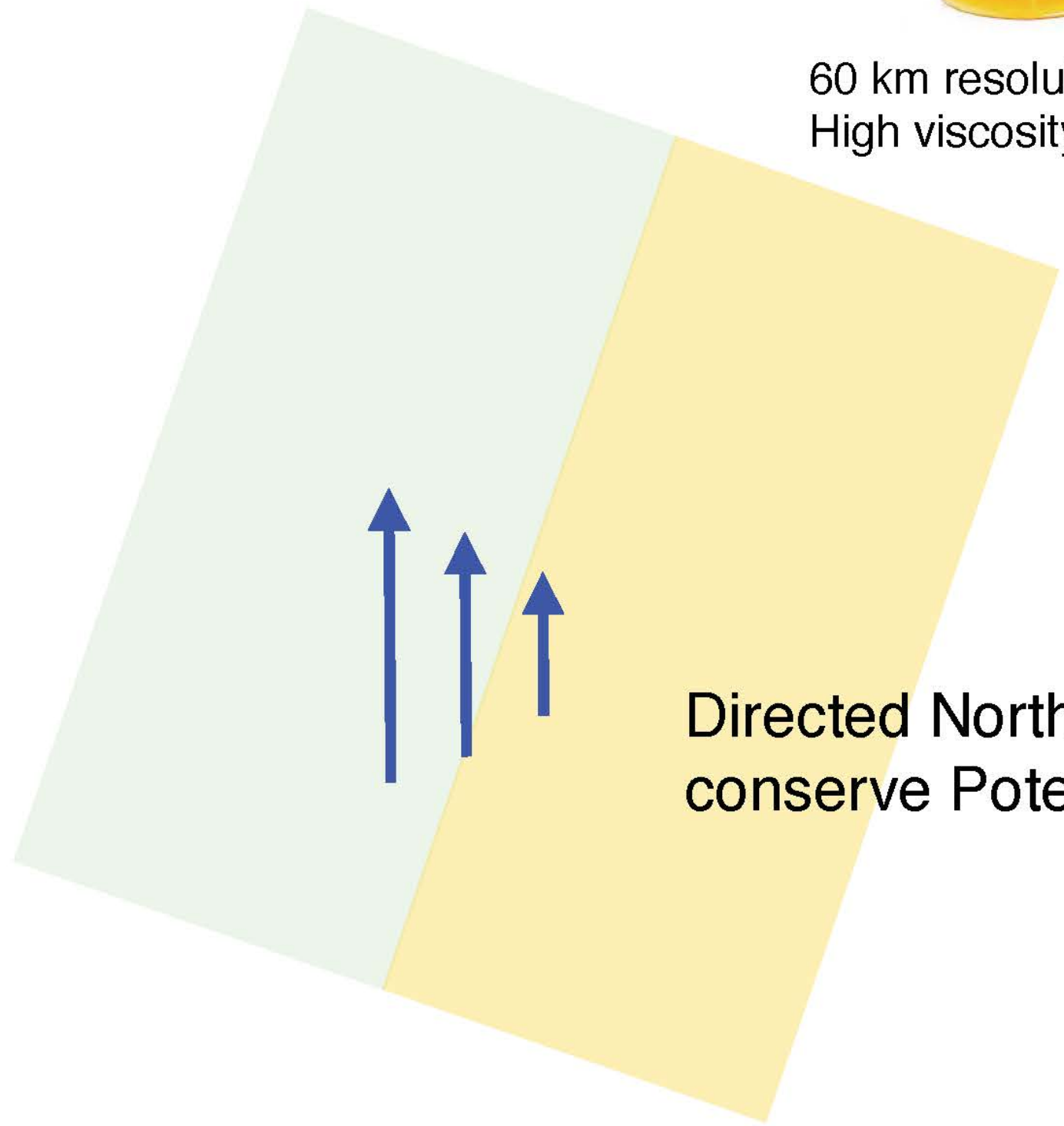

Directed North (higher  $f$ ) to  
conserve Potential vorticity

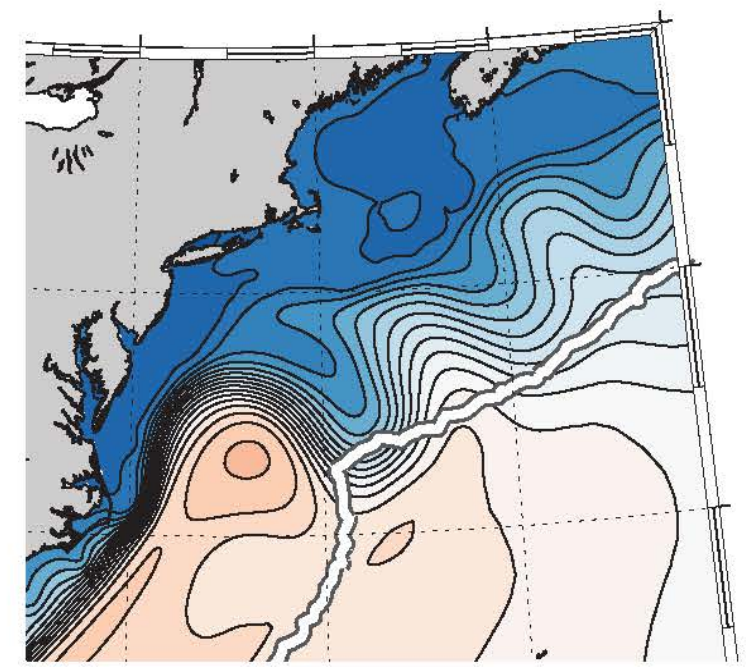

$$\frac{\zeta + f}{H}$$



Thank you

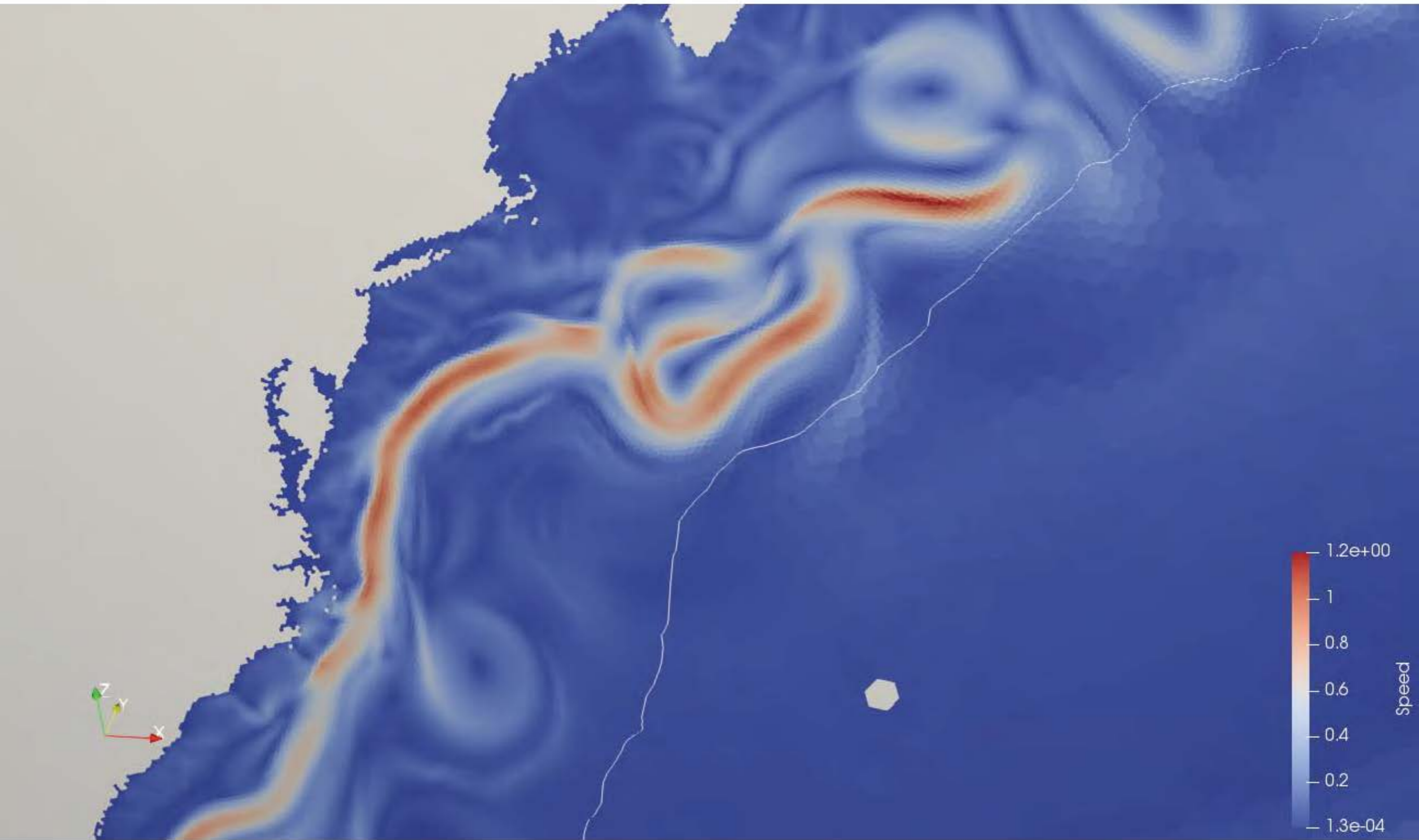

**Extra slides**



### Low-resolution

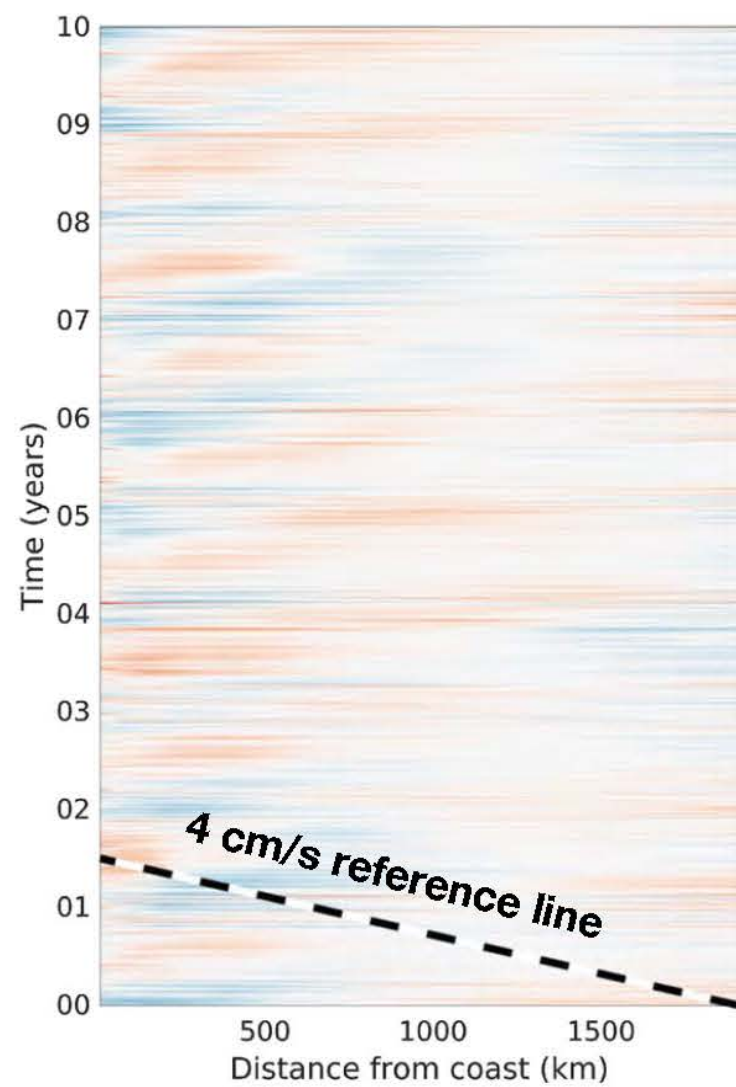

### Coastal-refined

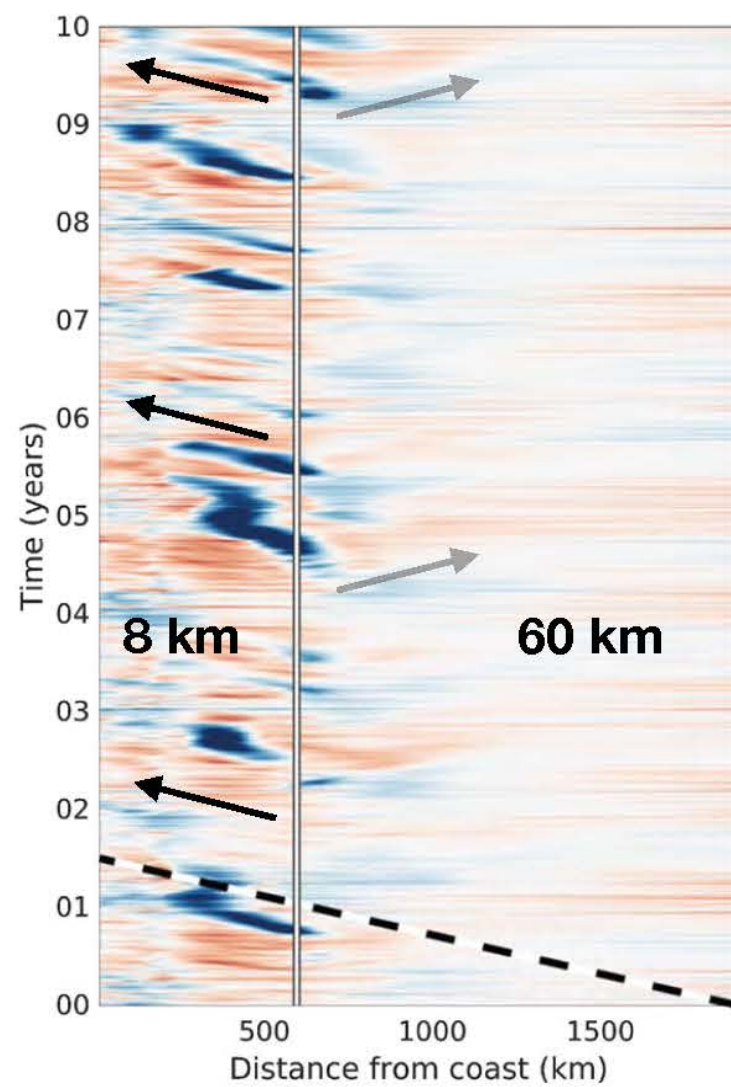

### High-resolution

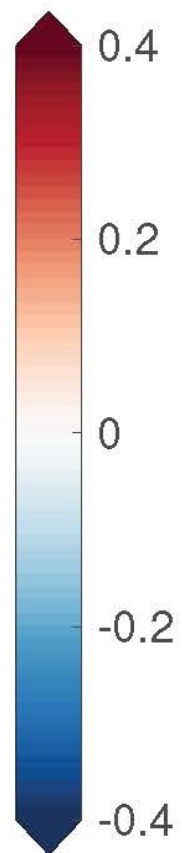
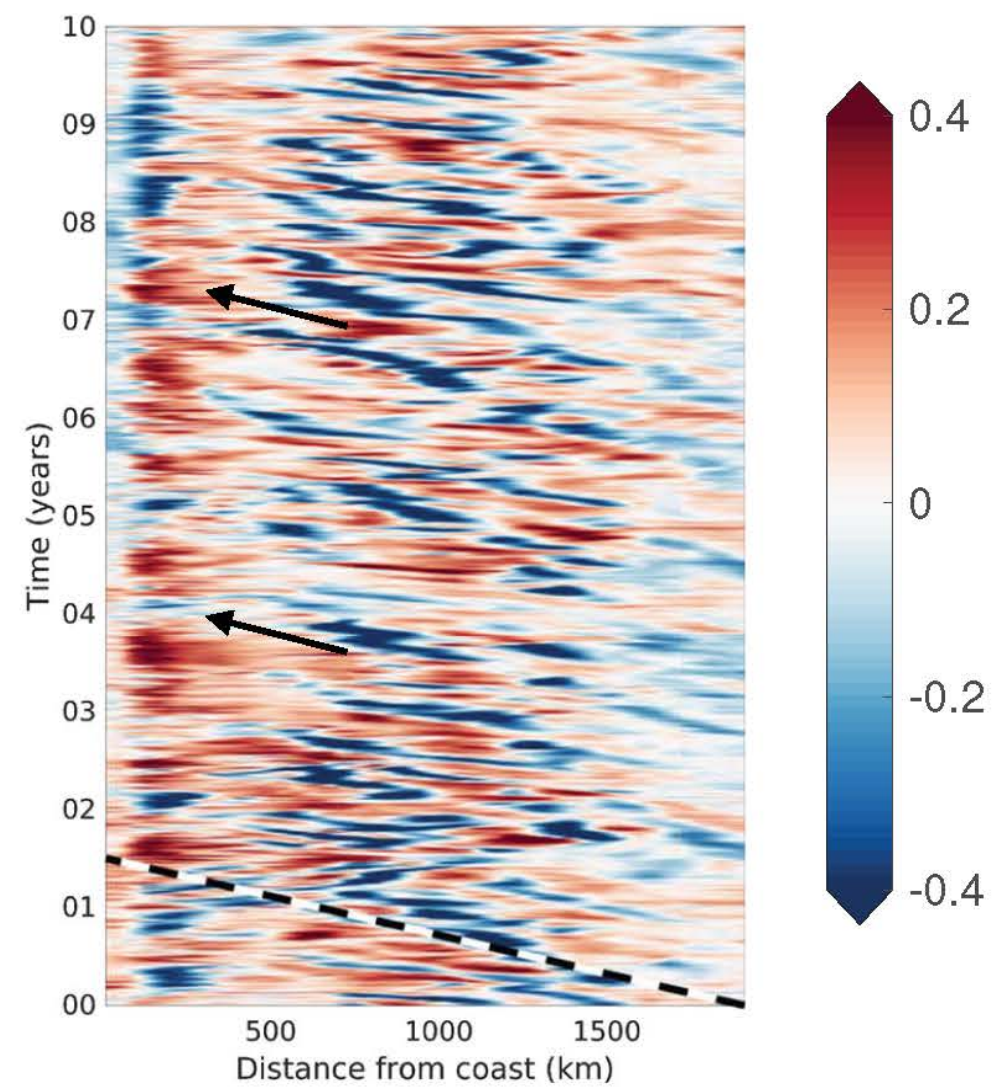

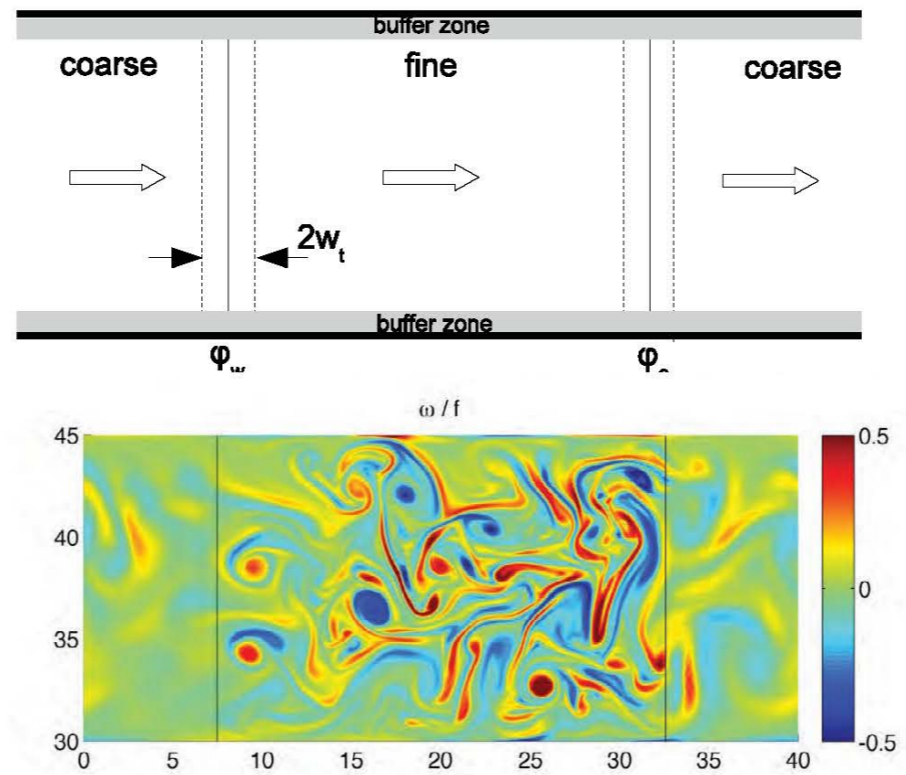

Danilov and Wang (2015)



# High-resolution

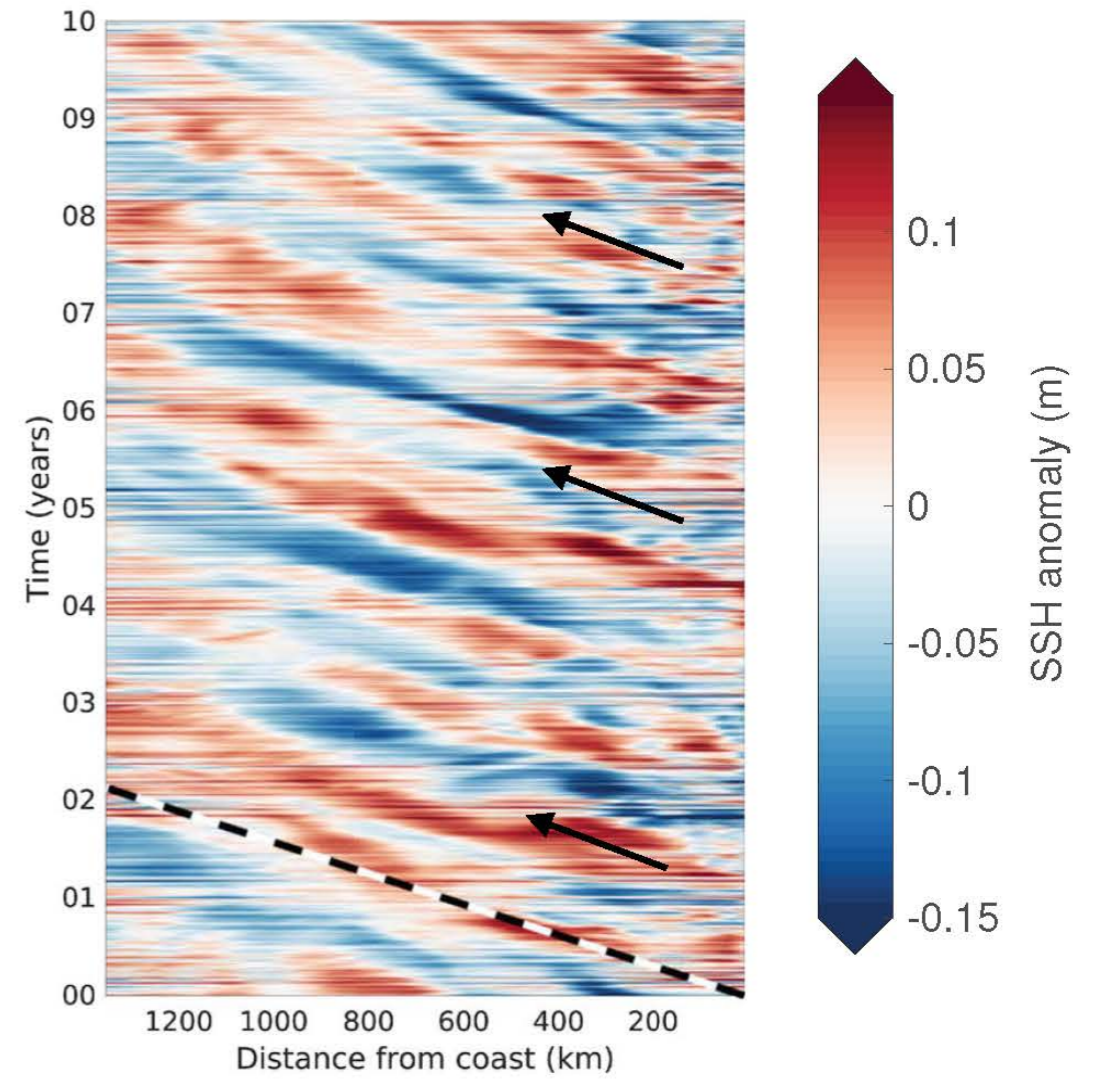

## Low-resolution

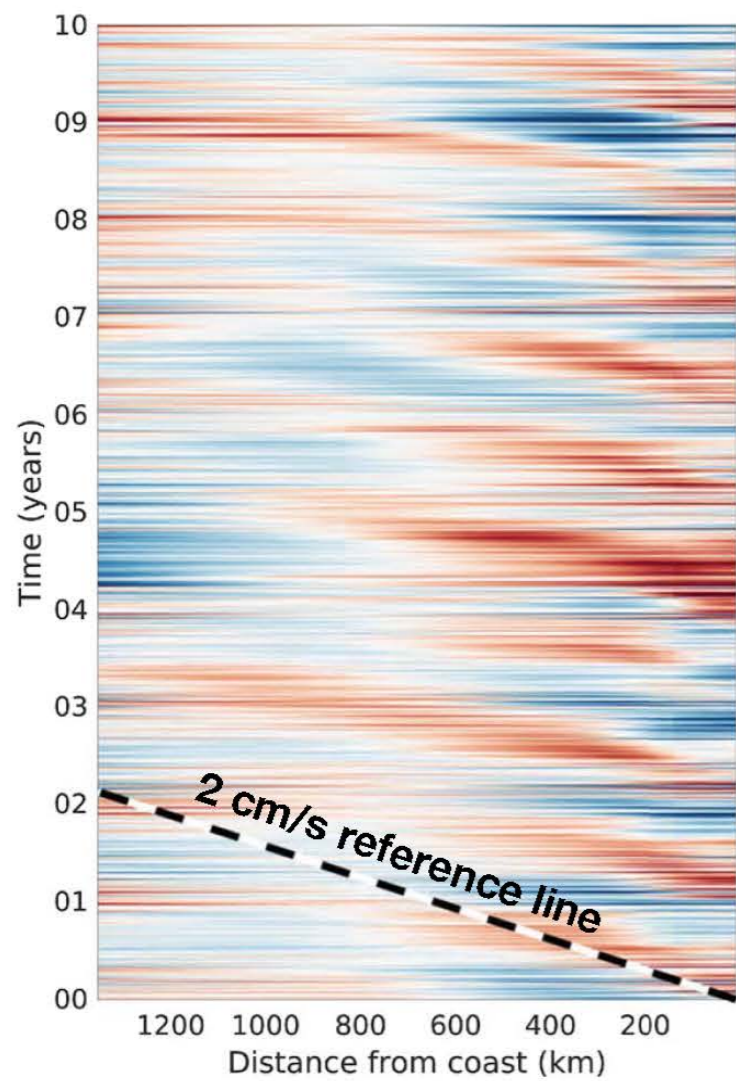

## High-resolution

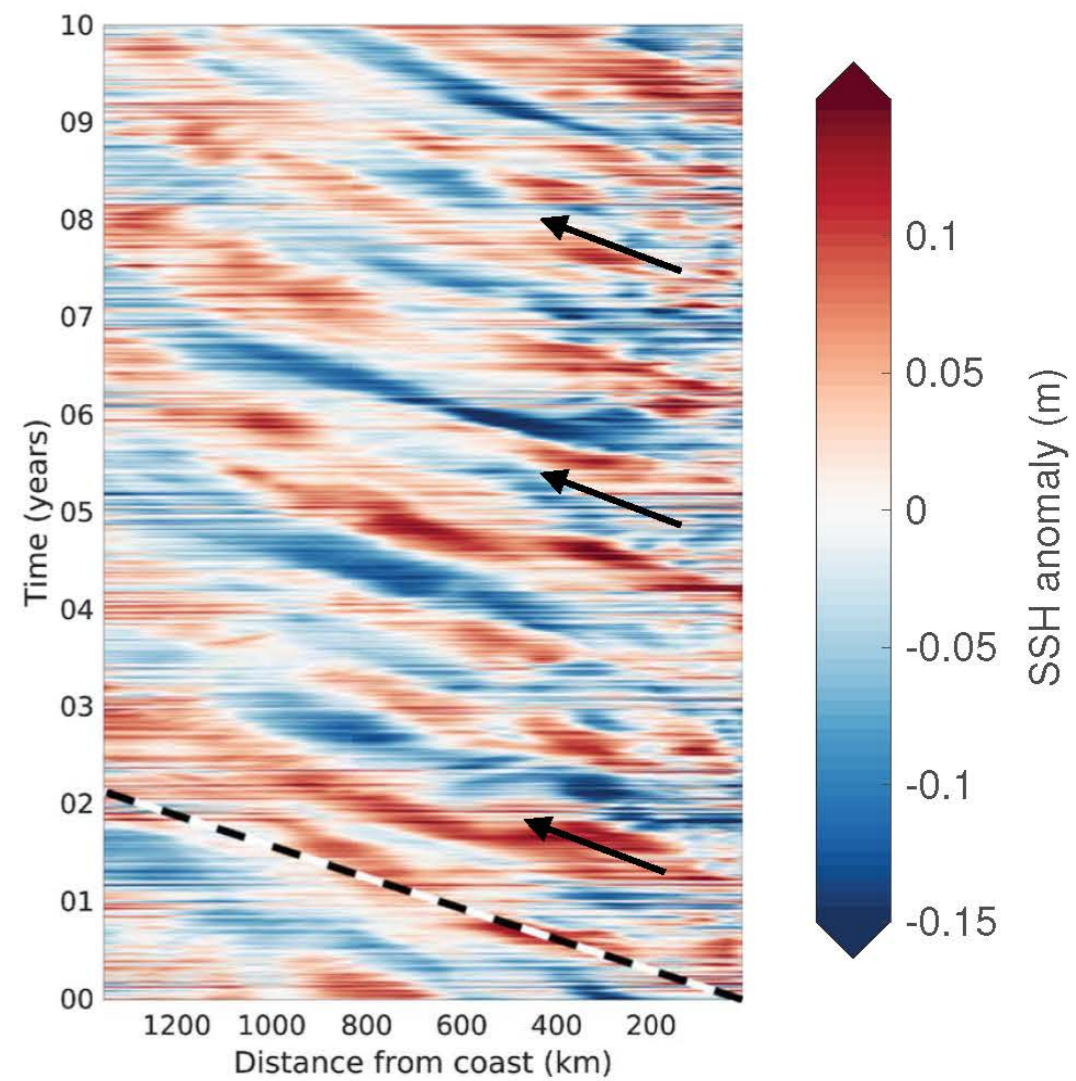



### Low-resolution

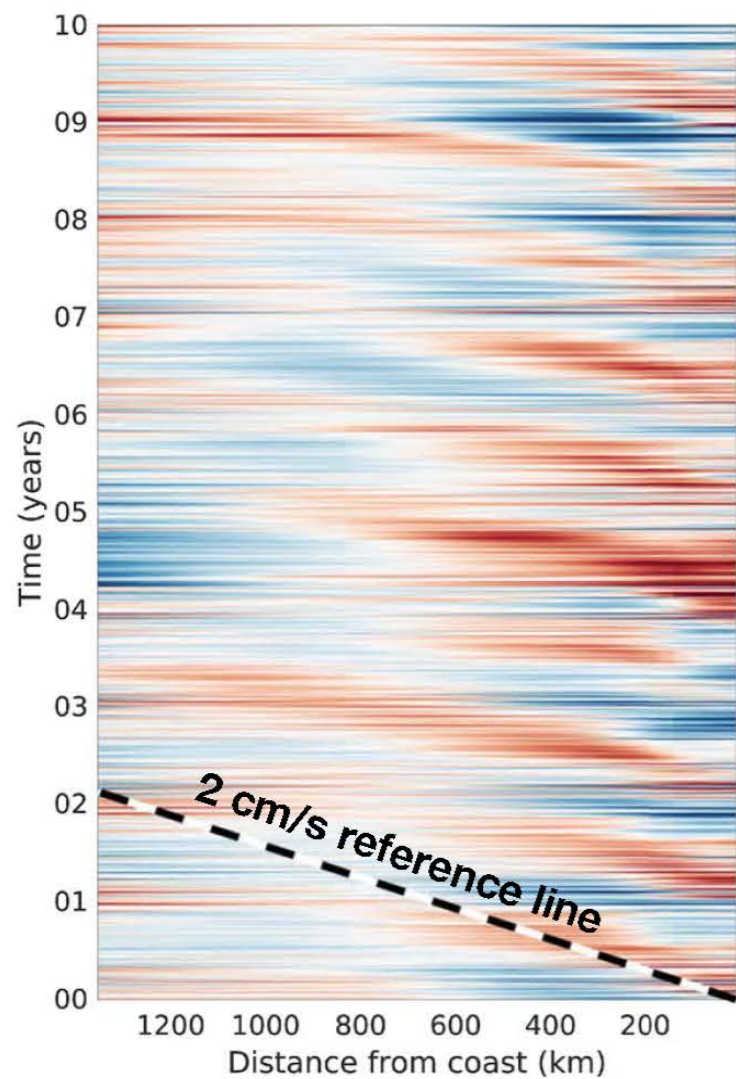

### Coastal-refined

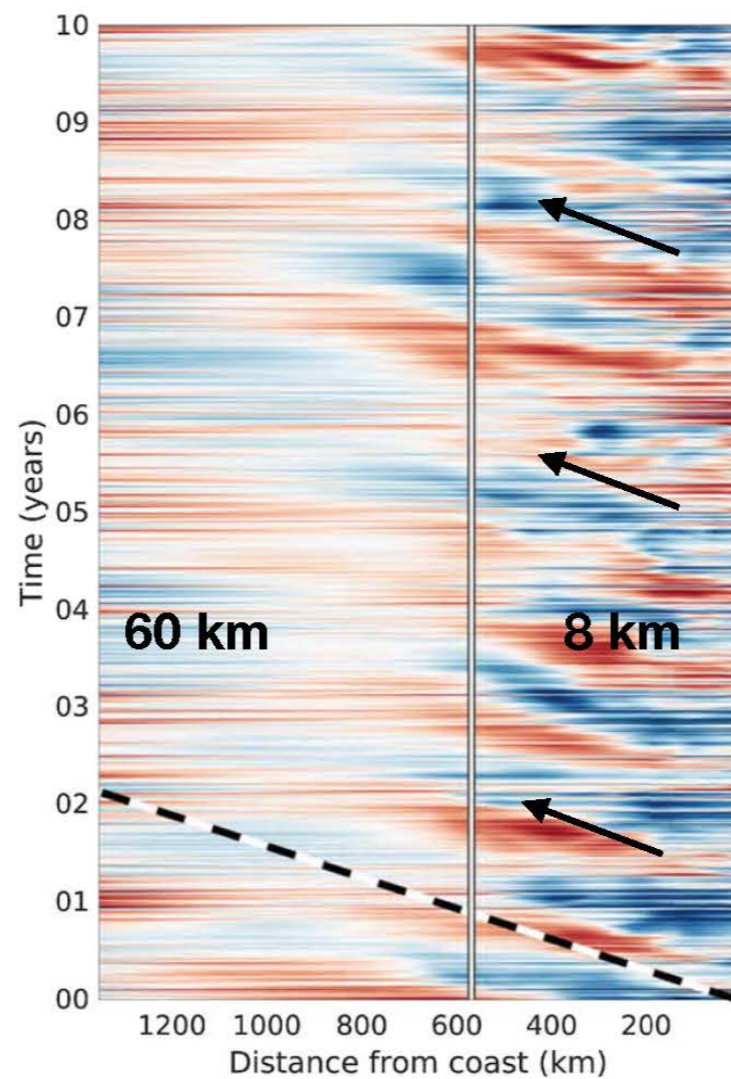

### High-resolution

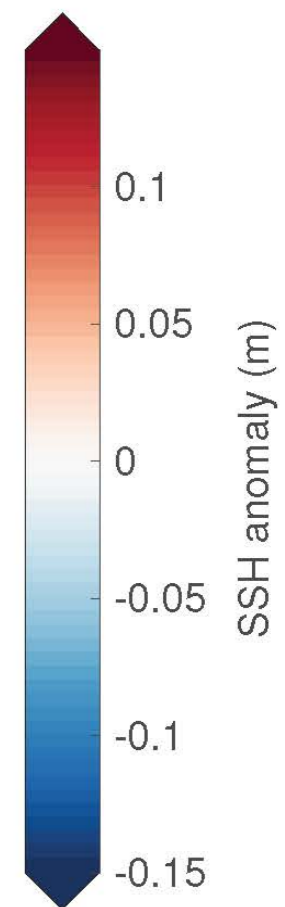
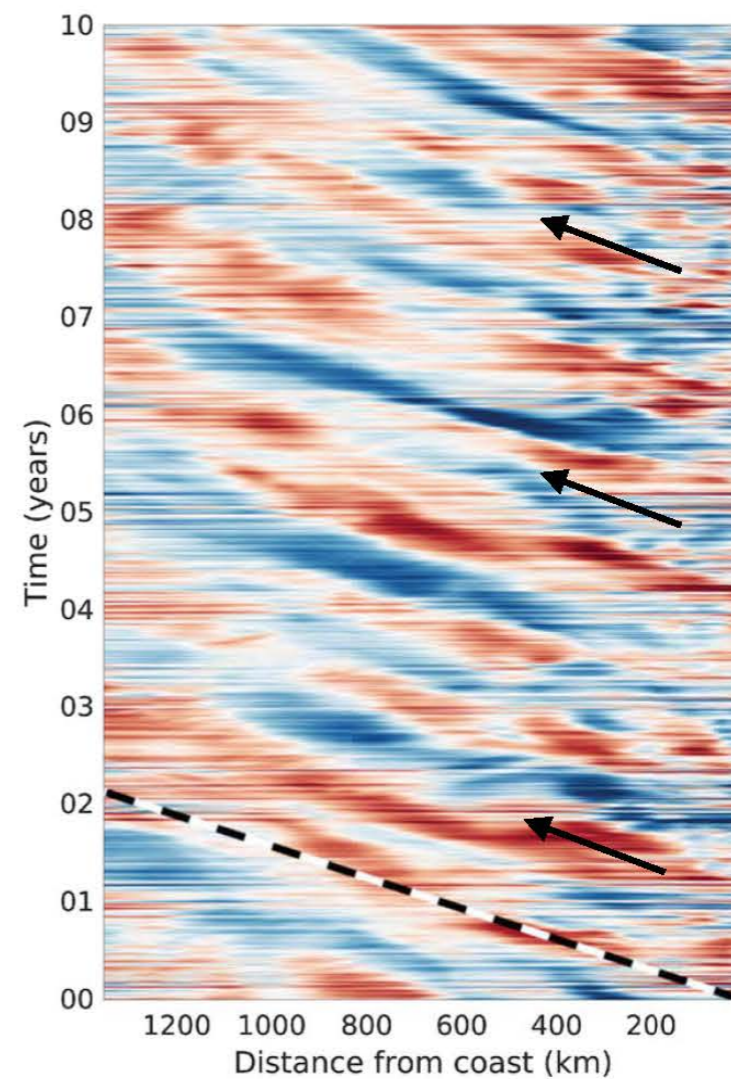

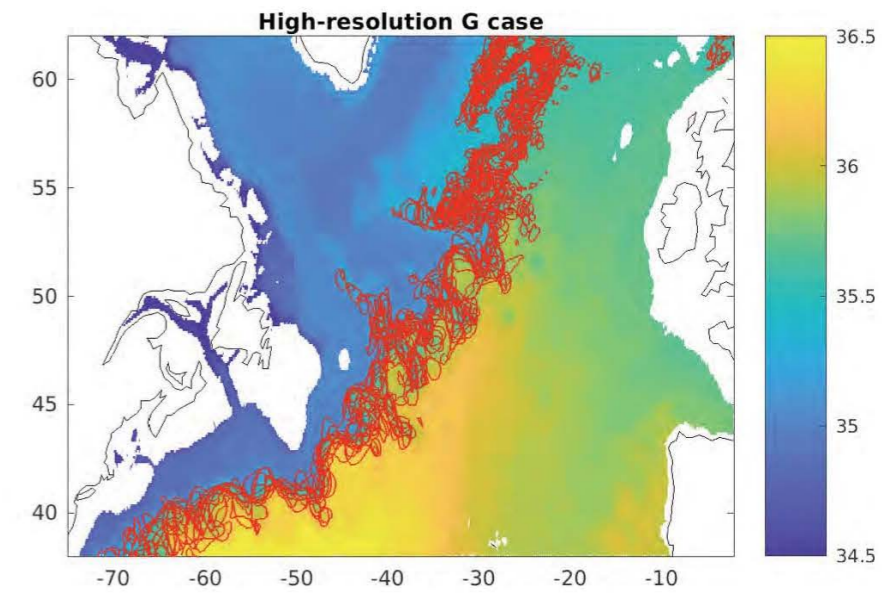
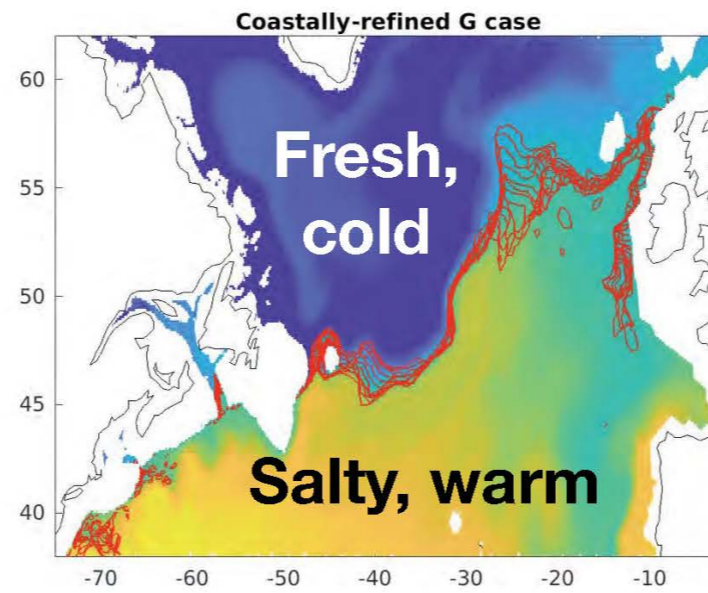
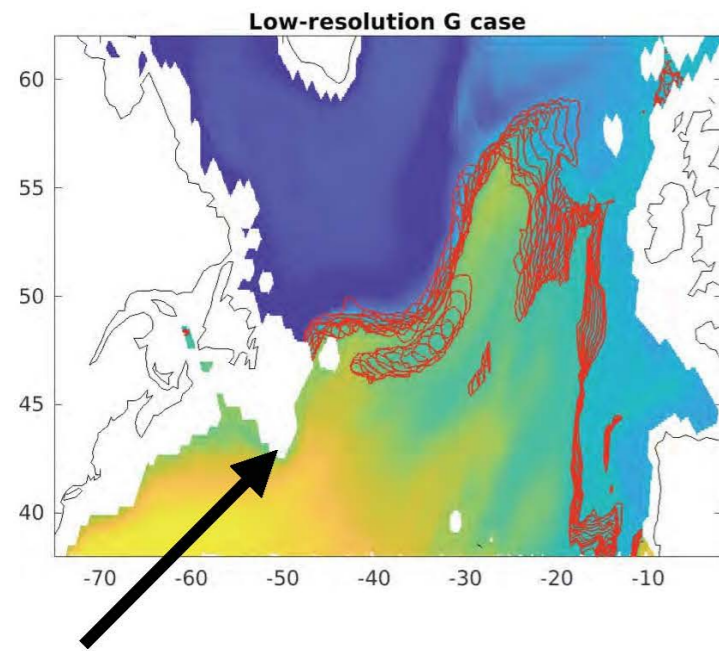

**Tail of the Grand Banks**



THE WESTWARD INTENSIFICATION OF WIND-DRIVEN OCEAN CURRENTS

Henry Stommel

(Contribution No. 408, Woods Hole Oceanographic Institution)

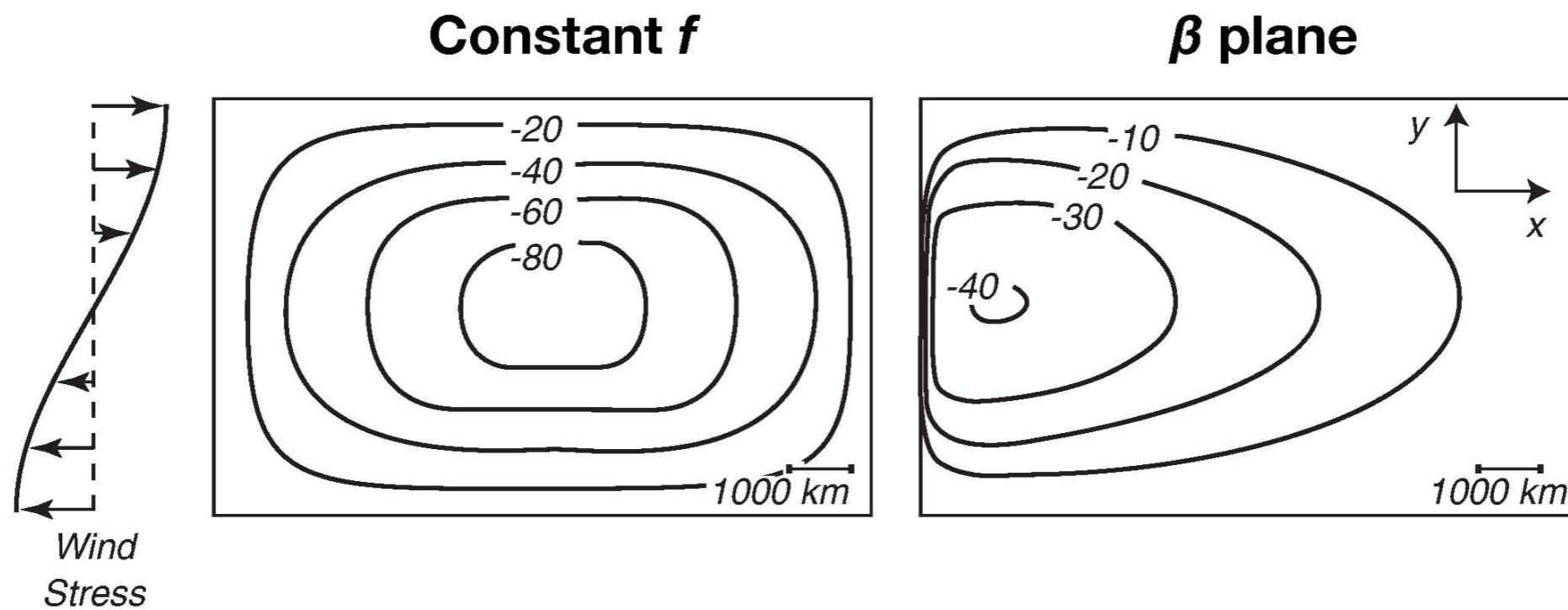

Stewart (2008) Fig 11.5 recreation of Stommel (1948) Fig. 4+5

[https://www.colorado.edu/oclab/sites/default/files/attached-files/stewart\\_textbook.pdf](https://www.colorado.edu/oclab/sites/default/files/attached-files/stewart_textbook.pdf)

# 1. Why do we want higher resolution models?

